

TYPICAL SYSTEM DIAGRAM

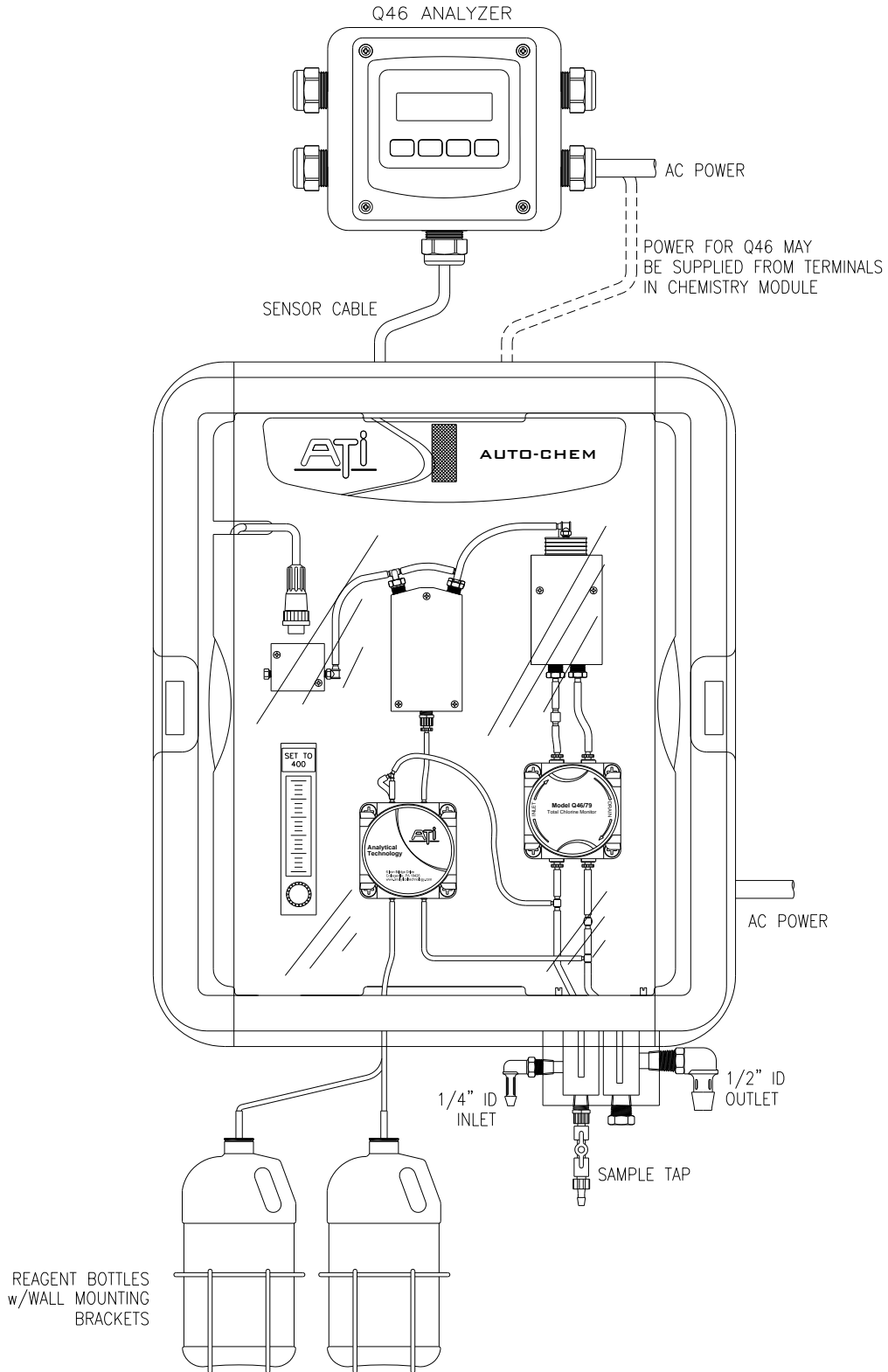

ATI-1014

CHEMISTRY MODULE DIMENSIONAL

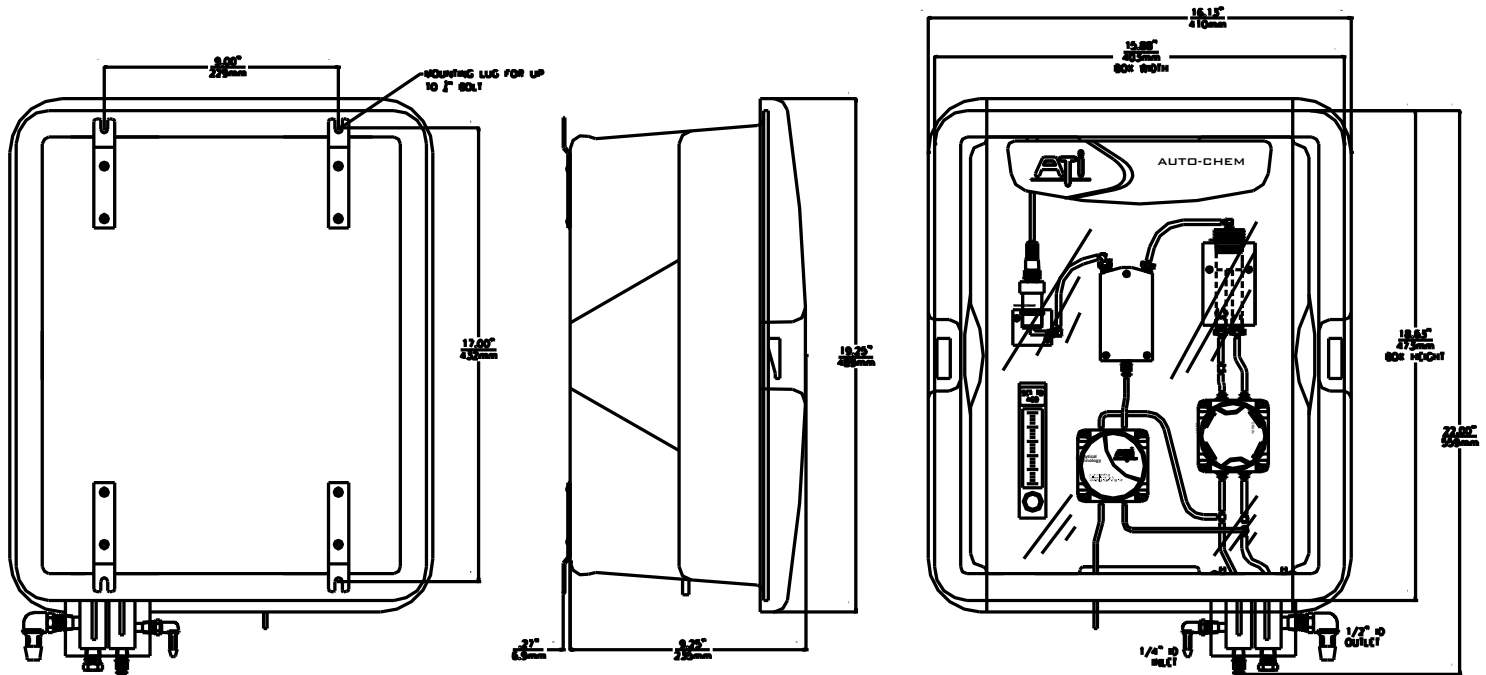

ATI-0998

ANALYZER DIMENSIONS (WALL MOUNT SHOWN)

Material: Polycarbonate
 Ratings: Nema 4X (IP-66)
 V-0 Fire Retardant

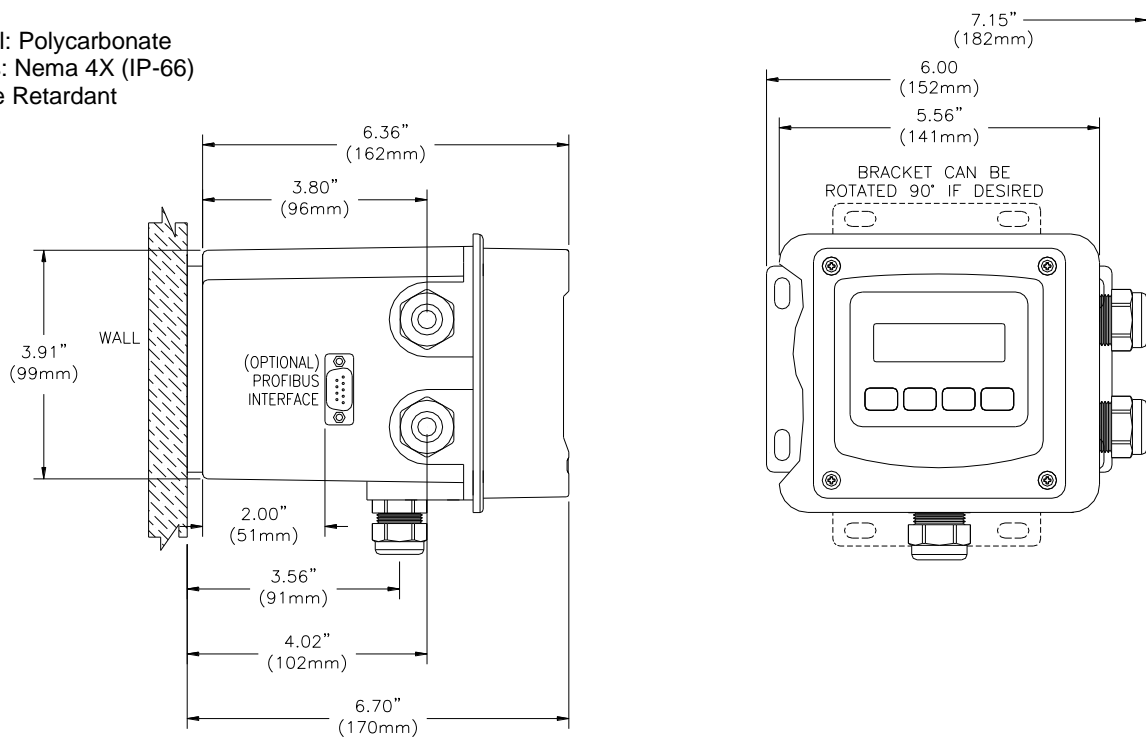

PIPE MOUNTING

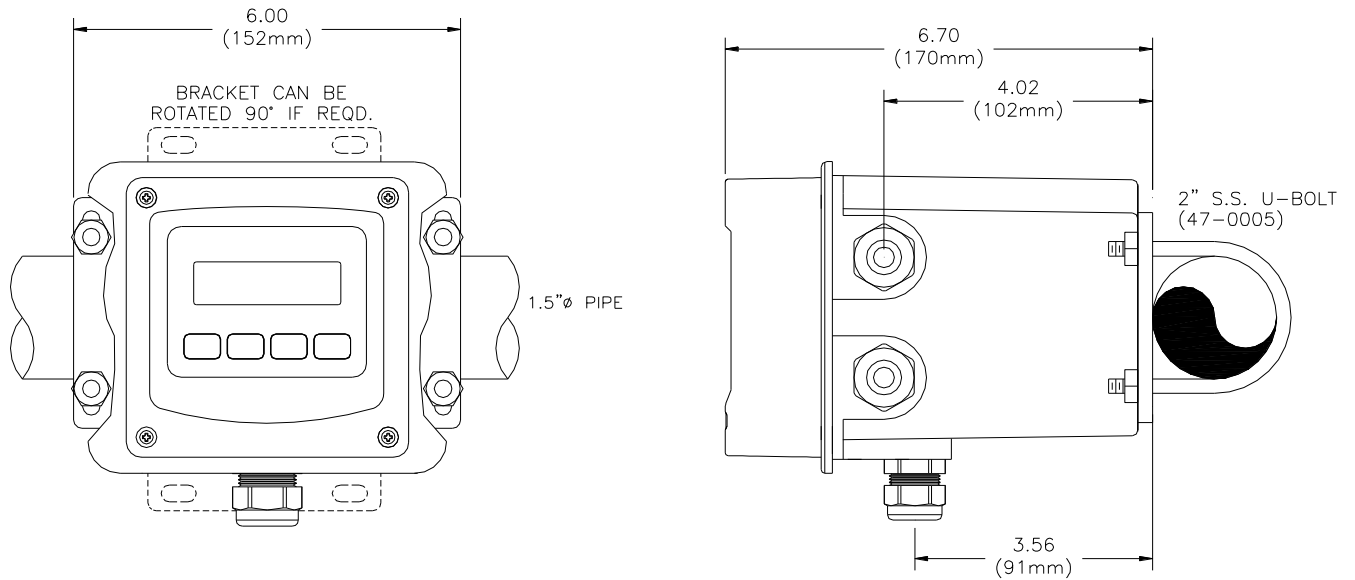

ATI-0927

PANEL MOUNTING

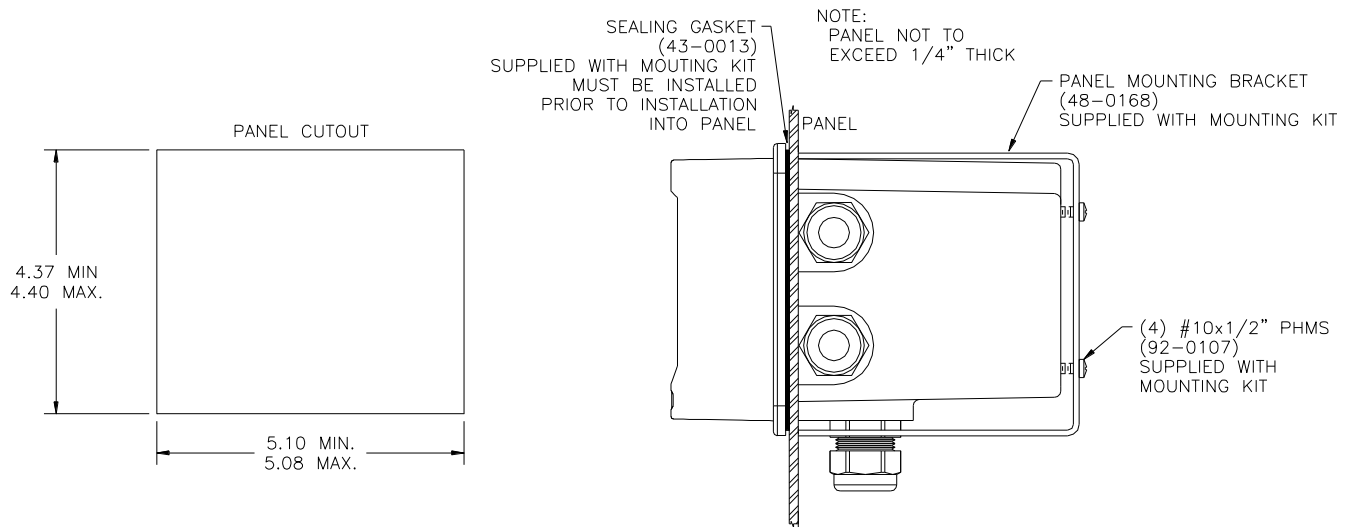

ATI-0928

POWER AND RELAY CONNECTIONS

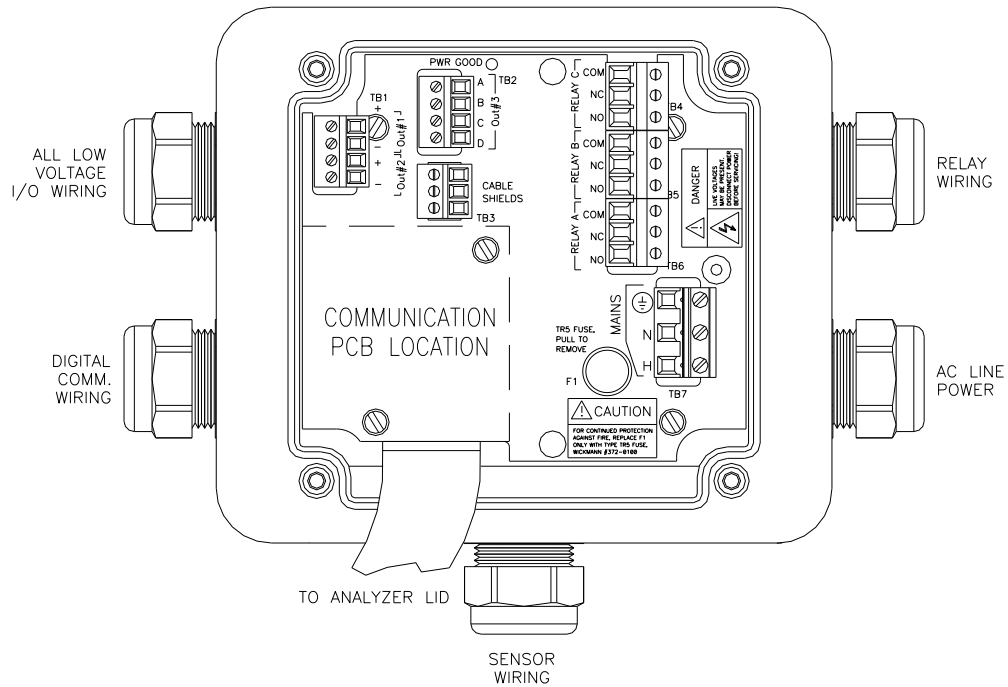

ATI-0930

RELAY WIRING TB4, 5, 6

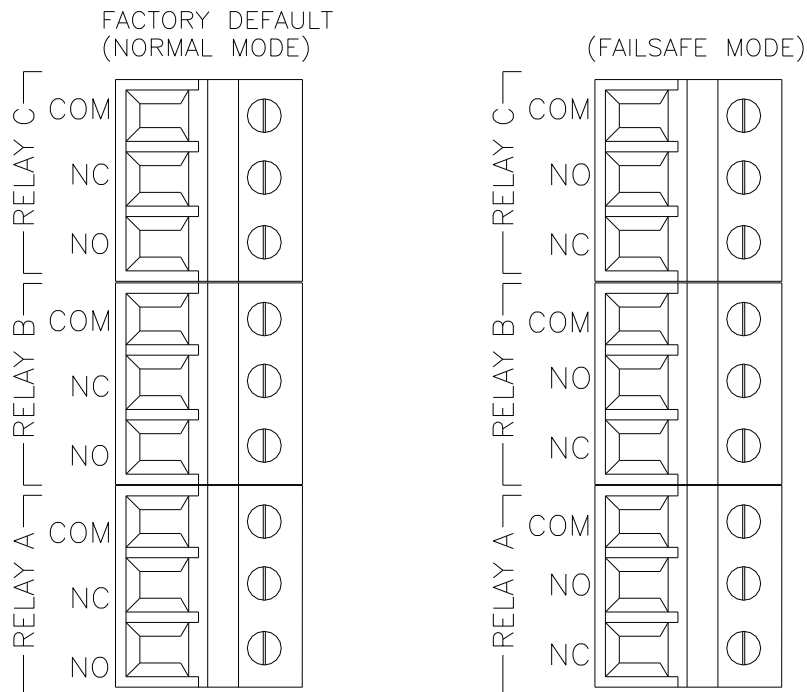

ATI-0931

CUSTOMER CONNECTIONS

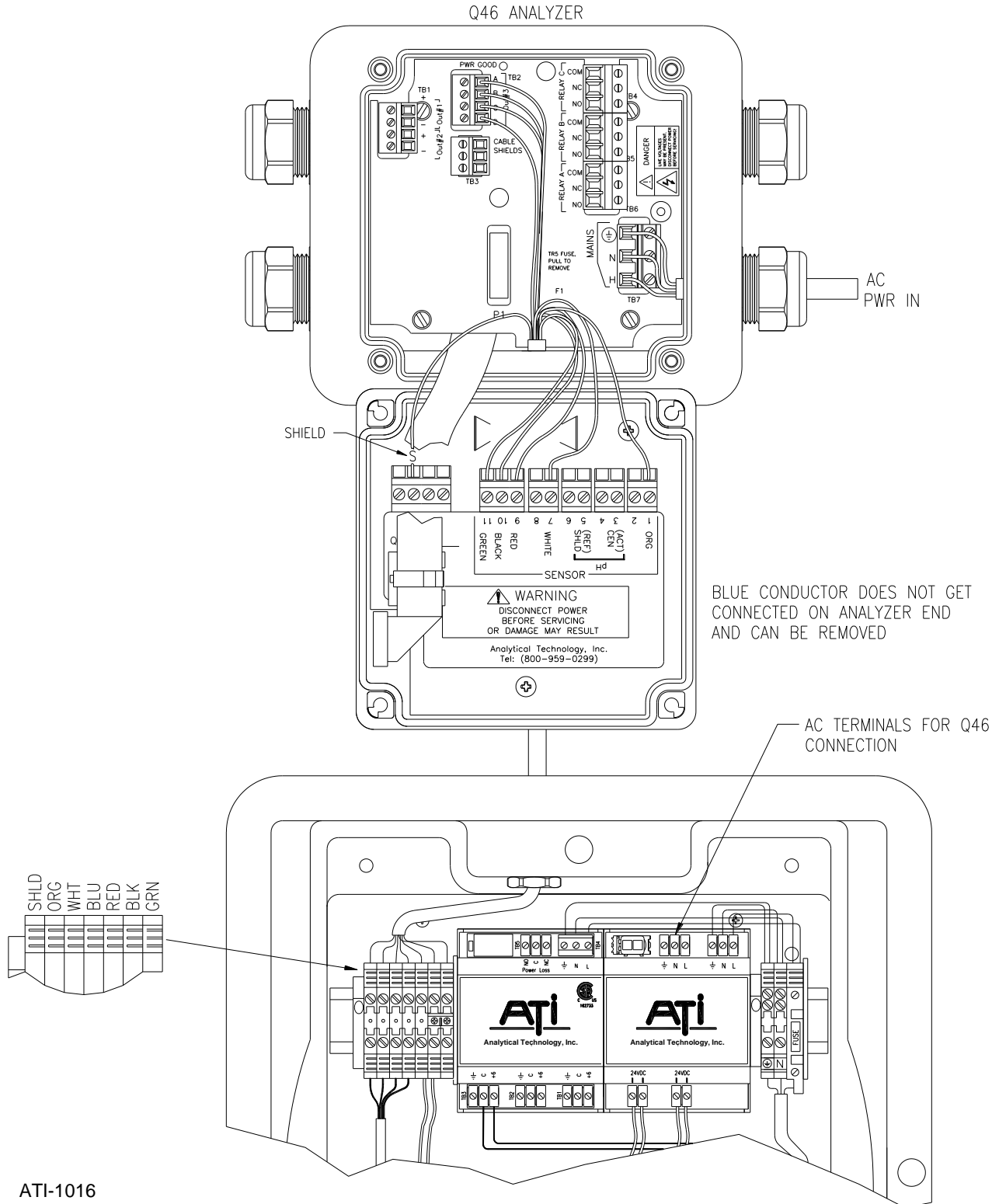

ATI-1016