



# MX 43

## ANALOG AND DIGITAL CONTROLLER



# MX 43

ANALOG AND DIGITAL CONTROLLER  
USER GUIDE

User Manuals in other languages are available on Website  
<https://teledynegasandflamedetection.com>



Copyright © December 2020 by TELEDYNE OLDHAM SIMTRONICS S.A.S.

All rights reserved. The reproduction of all or any section of this document in any form whatsoever without the written permission of TELEDYNE OLDHAM SIMTRONICS S.A.S. is forbidden.

The information contained in this manual is accurate to our knowledge.

As a result of continuous research and development, the specifications of this product may be modified at any time without prior notice.

The original version is the English one.

TELEDYNE OLDHAM SIMTRONICS S.A.S.  
Rue Orfila  
Z.I. Est – CS 20417  
62027 ARRAS Cedex

# Table of contents

<b>1</b>	<b>General Information.....</b>	<b>1</b>
1.1	User Manual.....	1
1.2	Symbols used.....	1
1.3	Safety Instructions.....	2
1.4	Important Information .....	2
1.5	Liability Limits .....	3
1.6	Warranty.....	3
<b>2</b>	<b>General Introduction .....</b>	<b>5</b>
2.1	Purpose of the MX 43 controller.....	5
2.2	The MX 43 Controller .....	7
2.3	The COM 43 Application .....	8
2.4	Firmplate .....	8
2.5	Wallmounted and Rack MX 43 codification .....	9
<b>3</b>	<b>Mechanical Installation .....</b>	<b>11</b>
3.1	MX 43 Controller.....	11
3.2	Digital Modules.....	13
<b>4</b>	<b>The MX 43 Controller.....</b>	<b>15</b>
4.1	Overview of the Unit.....	15
4.2	Front Plate.....	19
4.3	Alarm and Relay Thresholds .....	22
4.4	USB Key Operation.....	23
<b>5</b>	<b>Digital Modules.....</b>	<b>27</b>
5.1	Addressable Digital Modules .....	27
5.2	RS485 Transmission.....	28
5.3	Configuration of Communication .....	29
5.4	Relay modules .....	30
5.5	16-Logic Input Module .....	32
5.6	8-Analog Input Module.....	34
5.7	4-Analog Output Module.....	35

<b>6</b>	<b>Wiring and Electrical Connections</b> .....	<b>37</b>
6.1	Controller Connection.....	37
6.2	4- or 8-Relay Modules .....	42
6.3	16-Logic Input Module .....	43
6.4	8-Analog Input Module.....	43
6.5	4-Analog Output Module.....	44
<b>7</b>	<b>Menus</b> .....	<b>45</b>
7.1	General Menu Tree.....	45
7.2	Navigation Key Functions.....	45
7.3	Display in normal mode .....	46
7.4	Main Menu .....	47
<b>8</b>	<b>Main Part Numbers</b> .....	<b>59</b>
<b>9</b>	<b>Cleaning and maintenance</b> .....	<b>61</b>
9.1	Cleaning .....	61
9.2	Fuse replacement .....	61
<b>10</b>	<b>Certificate of Compliance</b> .....	<b>63</b>
<b>11</b>	<b>Technical Specifications</b> .....	<b>69</b>
11.1	MX 43 Controller.....	69
11.2	Relay Module .....	71
11.3	16-Logic Input Module .....	72
11.4	8-Analog Input Module.....	72
11.5	4-Analog Output Module.....	73
<b>12</b>	<b>RS485 Digital Output</b> .....	<b>75</b>
12.1	Card description.....	75
12.2	Transfer Table .....	76
12.3	Address Table.....	77
<b>13</b>	<b>Functional Safety</b> .....	<b>83</b>
13.1	Reliability data.....	83
13.2	Specific Conditions of Use .....	84
13.3	Specific Conditions of Use for FM.....	84
13.4	Connecting detectors other than TELEDYNE OLDHAM SIMTRONICS detectors to the MX 43 controller.....	84

<b>14</b>	<b>MX 43 in cabinets</b> .....	<b>87</b>
14.1	Presentation.....	87
14.2	Codification.....	88
14.3	Electrical connections.....	91
14.4	Control panel fixing .....	94
14.5	Internal implantation.....	97
14.6	Technical specifications .....	107



# 1 General Information

## 1.1 User Manual

The instructions given in this manual must be read thoroughly before installation and start-up, particularly those concerning the points related to the safety of the end-user. This user manual must be made available to every person involved in the activation, use, maintenance, and repair of the unit.





The information, technical data, and diagrams contained in this manual are based on the information that is available at a given time. In case of doubt, contact *TELEDYNE OLDHAM SIMTRONICS* for additional information.

The aim of this manual is to supply simple and accurate information to the user. *TELEDYNE OLDHAM SIMTRONICS* cannot be held liable for any misinterpretations in the reading of this manual. In spite of our efforts to produce an error-free manual, it may nonetheless contain some unintentional technical inaccuracies.

In the client's interest, *TELEDYNE OLDHAM SIMTRONICS* reserves the right to modify the technical characteristics of its equipment to increase their performance without prior notice.

The present instructions and their content are the inalienable property of *TELEDYNE OLDHAM SIMTRONICS*.

## 1.2 Symbols used

Icon	Significance
	This symbol indicates useful additional information.
	This symbol indicates: Earth ground connection.
	This symbol denotes: Protective earth terminal. A cable of the adequate diameter must be connected to ground and to the terminal having this symbol.
	This symbol denotes: <b>Attention! In the present mode of use, failure to adhere to the instructions preceded by this symbol can result in a risk of electric shock and/or death.</b>
	This symbol indicates: You must refer to the instructions.



European Union (and EEA) only. This symbol indicates that this product must not be discarded with household waste, as per the EEA directive (2002/96/EC) and your own national regulations.

This product must be disposed of at a collection point that is reserved for this purpose, for example, an official site for the collection of electrical and electronic equipment (EEE) in view of their recycling, or a point of exchange for authorized products that is accessible when you acquire a new product of the same type.

Any deviation as regards these recommendations for the disposal of this type of waste can have negative effects on the environment and public health, as these electric and electronic products generally contain substances that can be dangerous. Your full cooperation in the proper disposal of this product promotes a better use of natural resources.

## 1.3 Safety Instructions

Labels intended to remind you of the principal precautions of use have been placed on the unit in the form of pictograms. These labels are considered an integral part of the unit. If a label falls off or becomes illegible, please ensure it is replaced. The significance of the labels is detailed below.



The installation and electrical connections must be carried out by qualified personnel according to the instructions of the manufacturer and the standards of the competent authorities.

Failure to adhere to the instructions can have serious consequences on the safety of persons. Please be extremely rigorous as regards electricity and assembly (coupling, network connections).

Cables with an operating temperature of up to 75°C-167°F must be used because the temperature inside the controller can reach 60°C-140°F.

## 1.4 Important Information

The modification of the material and the use of parts of an unspecified origin shall entail the cancellation of any form of warranty.

The use of the unit has been projected for the applications specified in the technical characteristics. Exceeding the indicated values cannot in any case be authorized.



For MX43 in cabinet, refer to chapter 14 after reading this notice in its entirety



## 1.5 Liability Limits

Neither *TELEDYNE OLDHAM SIMTRONICS* nor any other associated company under any circumstances can be held liable for any damage, including, without limitations, damages for loss or interruption of manufacture, loss of information, defect of the MX 43 controller, injuries, loss of time, financial or material loss, or any direct or indirect consequence of loss occurring in the context of the use or impossibility of use of the product, even in the event that *TELEDYNE OLDHAM SIMTRONICS* has been informed of such damage.

## 1.6 Warranty

Under normal conditions of use and on return to the factory, parts and workmanship carry a two year warranty, excluding consumables such as backup power supplies, audio and visible alarms, etc.

# **MX 43**

ANALOG AND DIGITAL CONTROLLER  
USER GUIDE



## 2 General Introduction

### 2.1 Purpose of the MX 43 controller

This controller is intended for the continuous measurement and control of the gases present in the atmosphere.



Wall-mounted MX 43

Rack-mounted MX 43

EB type Cabinet to remote  
optional modules

Figure 1: Wall-mounted MX 43 and examples of the modules.

The system primarily comprises:

- a wall-mounted MX 43;
- different modules (detector with digital or analog output, logic inputs, analog inputs, relay outputs, and analog outputs).

The MX 43 instantly handles the measurements of detectors and input modules. As soon as the measurements reach the programmed limit, a sound and visual alarm are given. At the same time, the corresponding relay or relays are activated, in turn controlling the additional internal or external actions envisaged by the user.

The MX 43 controller is programmed by using the COM 43 application.

Figure 2 presents a configuration example.

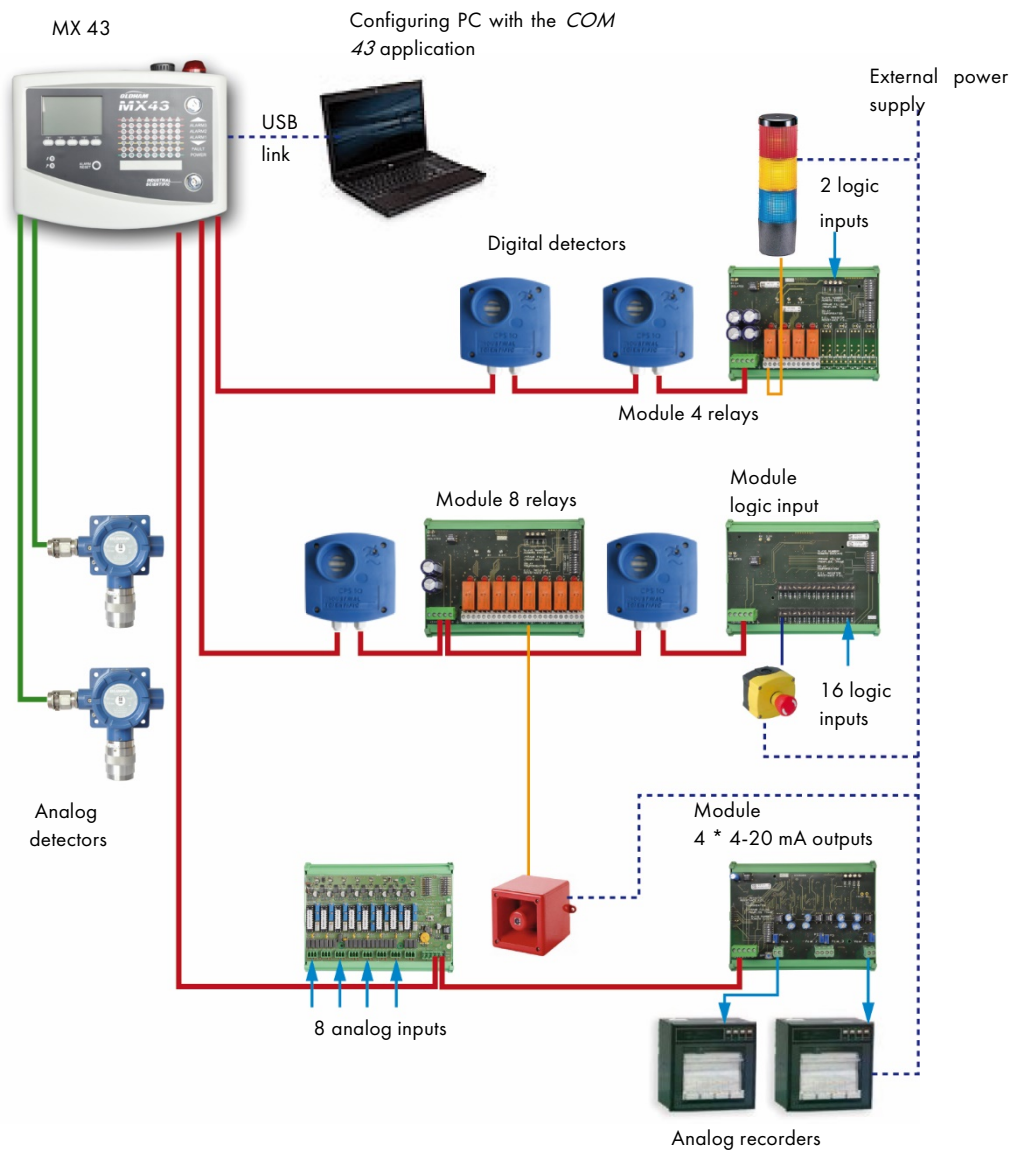

Figure 2: Example of an MX 43 configuration using different analog and digital detectors as well as digital modules.

## 2.2 The MX 43 Controller

### 2.2.1 Versions

The MX 43 controller is available in several versions:

- Wall-mounted version 4 lines.
- Wall-mounted version 8 lines.
- Rack-mounted version 8 lines.
- MX43S and MX43L in cabinet version 8 line



Figure 3: Wall-mounted version MX 43 (left illustration) or rack-mounted version (right illustration).

The following table details the different configurations that are possible, depending on the type of unit. On each line, it is possible to connect a 4-20mA analog detector or one, or several, digitally addressable modules.

Versions	Maximum number of				
	Modules (1)	Detectors	External relays	Logic inputs	Analog outputs
4 lines	16	16	8	16	16
8 lines	32	32	24	32	32

(1) Gas detectors, 4 or 8-analog output modules, and 16-logic input modules.

Table 1: Summary of the maximum capacity as per the controller type.

## 2.3 The COM 43 Application

This is intended for setting the MX 43 parameters from a Windows®-operated PC. The operation and use of this application is covered in a special training course.

## 2.4 Firmpplate

Example:

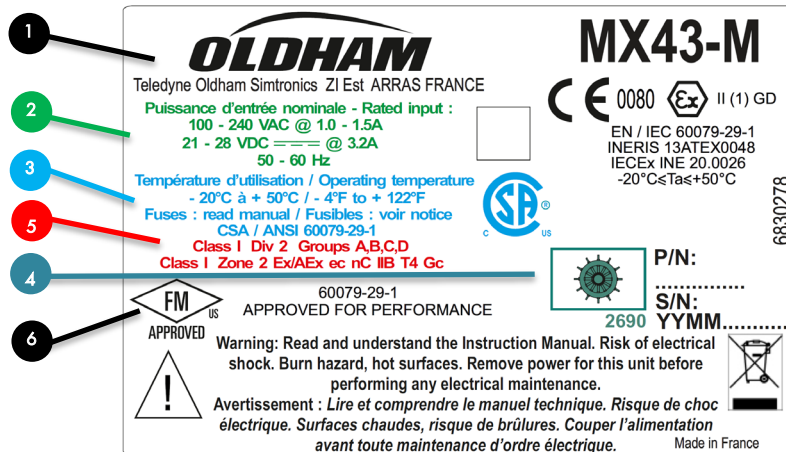

It contains relevant information with respect to the controller version (CSA or FM or ATEX variants).

Tag.	Description
1.	<p><u>All models:</u></p> <p>Name and address of the Manufacturer</p> <p>Product name</p> <p>CE marking with identification of the Notified Body that assessed the TELEDYNE OLDHAM SIMTRONICS manufacturing quality system (0080 – INERIS)</p> <p>ATEX marking (Performance requirements of gas detection systems for flammable gases)</p> <p>Part Number (P/N)</p> <p>S/N: Serial number (S:N): the first four digits correspond to the year (YY) and month (MM) of manufacture</p> <p>Warning</p>
2.	Electrical data: content differs depending on the model
3.	For all CSA models (Ord Loc and Haz Loc)
4.	Only for CSA Haz Loc approved versions
5.	Symbol of Marine Certification and number of the Approval Agency that issued the certificate (MX43M models)
6.	Only for FM approved versions

## 2.5 Wallmounted and Rack MX 43 codification

BaseA-B-C-D-E-F

Base A	B	C	D	E	F
WMX43M-4	MX43 wall-mounted version, 4 lines				
WMX43M-8	MX43 wall-mounted version, 8 lines				
WMX43C-4	MX43 wall-mounted version, 4 lines, CSA approved for Hazardous Location (2)				
WMX43C-8	MX43 wall-mount version, 8 lines, CSA approved for Hazardous Location (2)				
WMX43E-4	MX43 wall-mounted version, with one 4-analog-input card (1)				
WMX43E-8	MX43 wall-mounted version, with one 8-analog-input card (1)(2)				
WMX43R-8	MX 43 rack version, 8 lines				
	Controller language				
	1	French			
	2	English, German, Russian, Chinese, French			
		Strobe colour and Horn			
		0	Without		
		A	With Red Strobe and horn		
		B	With Blue Strobe and horn		
			Battery		
			0	No battery	
			B	With battery	
				Option	
				0	no option
				1	with COM43
				2	with USB datalogging capability
				3	with COM43 & USB datalogging capability
					Digital output
				0	WithoutSans
				1	With RS485 Modbus output

(1) this version is exclusively dedicated to replace existing controllers such as MX 42 or MX 48 connected to mV flammable gas detectors

(2) Options (Battery, Strobe, Horn) available for Ordinary Location only, not available for Hazardous Location

# **MX 43**

ANALOG AND DIGITAL CONTROLLER  
USER GUIDE





## 3 Mechanical Installation



*This chapter details the mechanical installation of MX 43 and the digital modules.*

### 3.1 MX 43 Controller

#### 3.1.1 Location

The MX 43 shall be installed in premises without explosive atmospheres, away from direct exposure to sunlight, and protected from humidity, dust, and temperature variations. It shall preferably be located in a monitored environment (guardhouse, control room, or instrument room, for example).

#### 3.1.2 Attachment of the wall enclosure

Access to the controller must be ensured in the front in order to facilitate adjustments, monitoring, and cabling. A space of 400 mm is necessary in front of the MX 43 for opening the door.

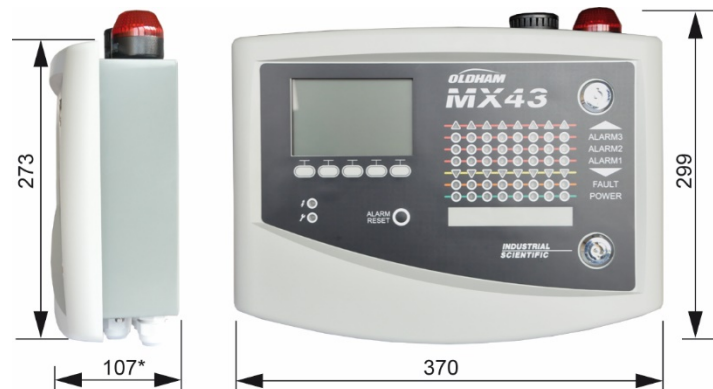

*(\*) rear fixing legs included.*

**Figure 4: Size of the wall-mounted version.**

# MX 43

ANALOG AND DIGITAL CONTROLLER  
USER GUIDE

Use 3 fixing screws 4x25 mm for fixing the case support.

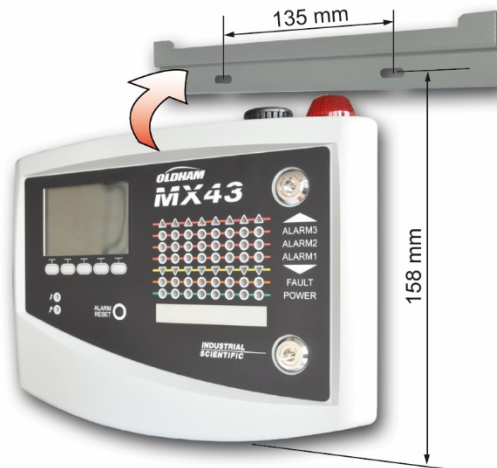

Figure 5: Fixing of the wall- mounted version MX 43 with a support plate.

### 3.1.3 Setting-up of a 19" Rack – 4 U

Access to the unit must be ensured in order to facilitate adjustments and monitoring, and likewise in the back in order to allow easy access to the different connectors at the rear.

This rack is built into a bay or a standard 19" cabinet. You should leave ½ U (22 mm) of space above and below the rack so as to assure the proper ventilation of the MX 43.

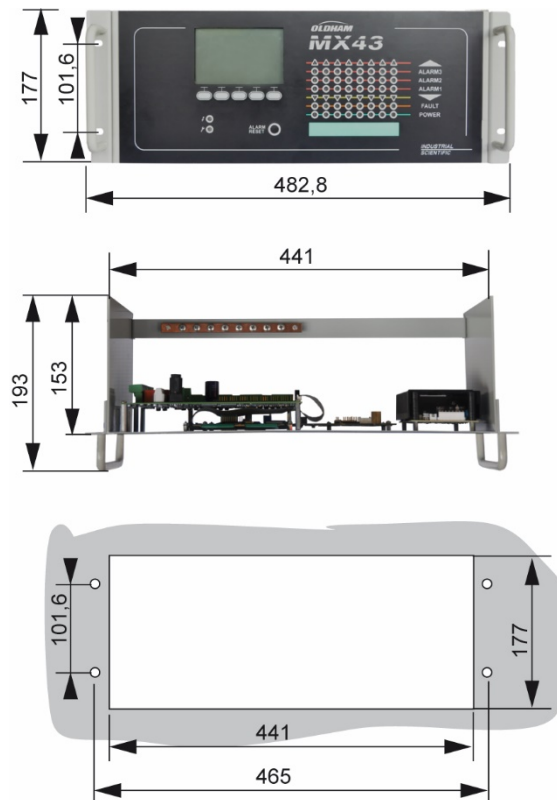

Figure 6: Size of the rack-mounted version.

## 3.2 Digital Modules



The cabling is the subject of the paragraph *Wiring and Electrical Connections* on page 37.

### 3.2.1 Gas detectors



Refer to the manual supplied with each detector.

#### Location

Each detector shall be positioned at ground level, on the ceiling, at the height of the respiratory tract, or near air extraction ducts, depending on the density of the gas to be detected or applied. Heavy gases are detected close to the ground, while lighter gases are present along the ceiling. If necessary, contact *TELEDYNE OLDHAM SIMTRONICS* for any questions regarding proper detector positioning.

#### Fixing

The detectors shall preferably be positioned in an accessible place so that inspections and maintenance can be carried out as well as to ensure the absolute safety of the operators. The detectors must not be obstructed by anything that will prevent them from measuring the ambient environment to be checked.

If mounting an OLCT 10N on a vertical surface, position the cable gland downwards.

### 3.2.2 Other models

#### Location

The relay modules, logic outputs, analog outputs, and analog inputs are positioned depending on the installation layout, mandatorily in places free from explosive atmospheres, protected from humidity, dust, and temperature variations; for example in technical cabinets.

#### Fixing

These modules shall be mounted on a DIN rail in a cabinet or in an electrical cabinet.

For relay modules connected to low voltage electrical parts, the installation is carried out according to the standards in force.



Figure 7: Fixing of a module (relay, logic outputs, or analog outputs or inputs) on a DIN rail.

# **MX 43**

ANALOG AND DIGITAL CONTROLLER  
USER GUIDE



## 4 The MX 43 Controller



The versions in cabinet have differences in the arrangement of the components. See specific chapter 14 after reading this notice in its entirety.

### 4.1 Overview of the Unit

#### 4.1.1 External view

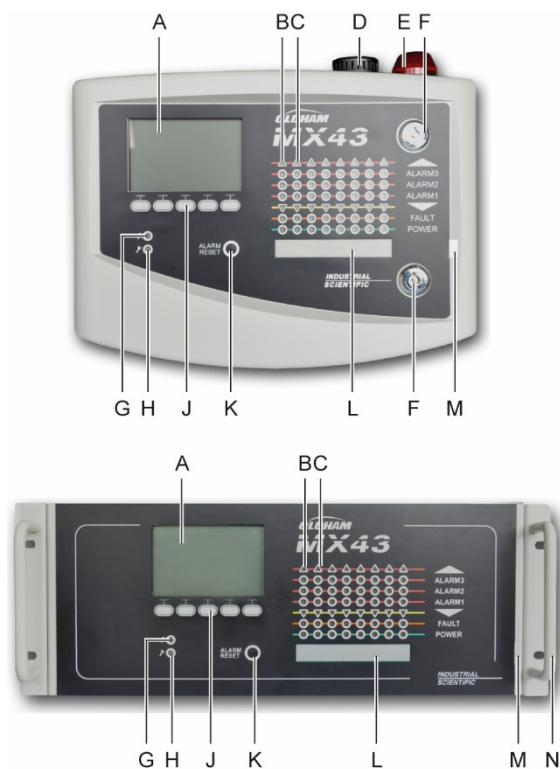

Rep.	Function
A.	Monochromatic, back-lit graphic LCD display
B.	Zone 1 status indicator
C.	Zone 2 status indicator
D.	Integrated siren (option)
E.	Integrated flash (optional)
F.	Lock
G.	Start/Stop indicator

Rep.	Function
H.	Failure/maintenance indicator
J.	Contextual soft keys
K.	Alarm release key
L.	Free identification of zones
M.	Strip for locating zones
N.	Handle

Figure 8: External view of the wall-mounted and rack-mounted versions.

**4.1.2 Internal view**

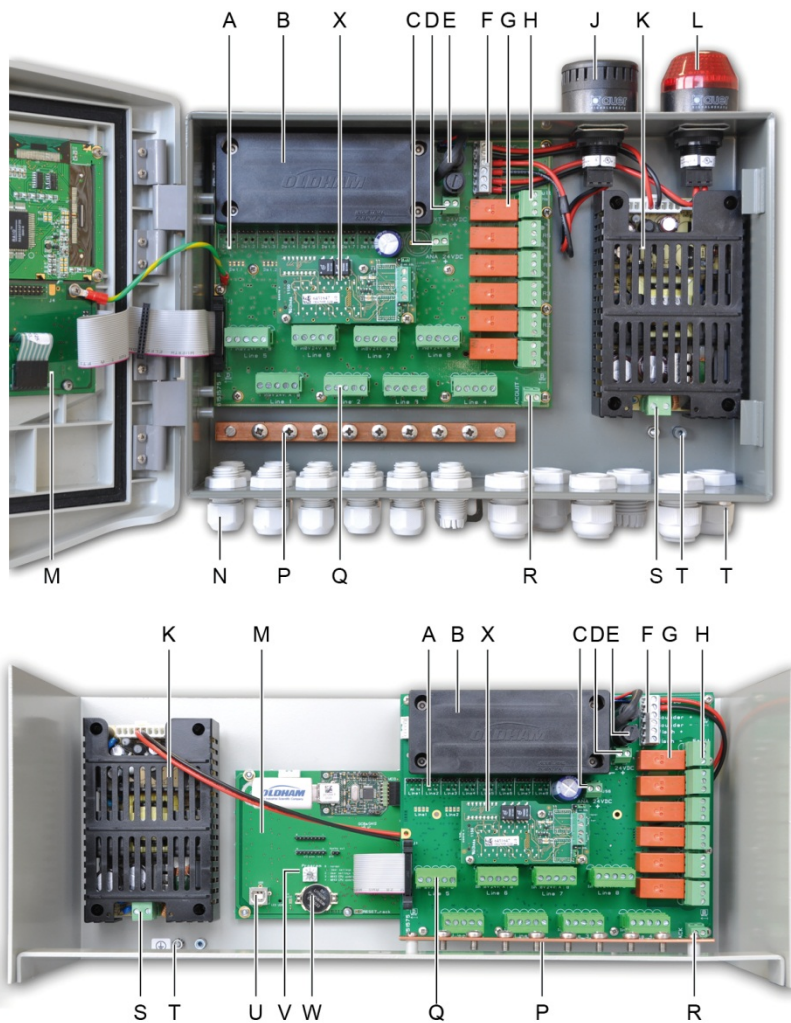

**Figure 9: Internal view of the wall-mounted version (top) and rack- mounted version (bottom).**

Rep	Function																		
A.	LED digital communication status indicators. The information displayed by each red-green diode pair of a line is interpreted as follows:																		
	<table border="1"> <thead> <tr> <th colspan="2">LED Status</th> <th rowspan="2">Significance</th> </tr> <tr> <th>Red</th> <th>Green</th> </tr> </thead> <tbody> <tr> <td>Fast blinking</td> <td>Fast blinking</td> <td>Normal functioning of the line - Tx communication request - Rx: response of digital module(s).</td> </tr> <tr> <td>Irregular blinking</td> <td>Irregular blinking</td> <td>Bad communication quality with at least one module.</td> </tr> <tr> <td>Blinks 1X/sec</td> <td>Off</td> <td>Communication failure. Absence or failure of line modules. A communication failure is signaled by the activation of the internal buzzer, the presence of the orange <i>failure</i> indicator and via the default relay.</td> </tr> <tr> <td>Off</td> <td>Off</td> <td>No digital module active on the line.</td> </tr> </tbody> </table>		LED Status		Significance	Red	Green	Fast blinking	Fast blinking	Normal functioning of the line - Tx communication request - Rx: response of digital module(s).	Irregular blinking	Irregular blinking	Bad communication quality with at least one module.	Blinks 1X/sec	Off	Communication failure. Absence or failure of line modules. A communication failure is signaled by the activation of the internal buzzer, the presence of the orange <i>failure</i> indicator and via the default relay.	Off	Off	No digital module active on the line.
LED Status		Significance																	
Red	Green																		
Fast blinking	Fast blinking	Normal functioning of the line - Tx communication request - Rx: response of digital module(s).																	
Irregular blinking	Irregular blinking	Bad communication quality with at least one module.																	
Blinks 1X/sec	Off	Communication failure. Absence or failure of line modules. A communication failure is signaled by the activation of the internal buzzer, the presence of the orange <i>failure</i> indicator and via the default relay.																	
Off	Off	No digital module active on the line.																	
B.	Optional 24 VDX NiMH battery pack. (not available on MX43S and MX43L)																		

Rep	Function
C.	Terminal block for the analog card power supply.
D.	Connector for the direct current external supply.
E.	Battery fuse (4A) and external power supply (21 to 28 VDC, 3.2 to 4 A max.).
F.	Connector for <ul style="list-style-type: none"> <li>- Main entry Power Supply 24VDC</li> <li>- Internal siren 24 VDC – 19mA max. Sounder+ and Sounder- terminals</li> <li>- Internal flash 24 VDC – 40 mA max. Flash+ and Flash-terminals</li> </ul>
G.	Relays of alarms, from high to low Failure, R5, R4, R3, R2, R1. <ul style="list-style-type: none"> <li>- Failure: Non-configurable failure relay</li> <li>- R1 to R5: Configurable alarm relays</li> <li>- Corresponding LED indicator: Lit when relay is under voltage.</li> </ul> <p><b>Configuration of Alarm Thresholds</b></p> <p>The alarm thresholds for relays R1 to R5 can only be configured using the COM 43 software. The silkscreen image displays relays off line.</p> <p>Relays R1 to R5 can be configured in either positive or negative security mode. COM 43 programming in:</p> <ul style="list-style-type: none"> <li>- <i>Normal mode</i>: Operation of the relay as per the normal alarm management (the relay is released only if the event exceeds the duration of the time delay).</li> <li>- <i>Buzzer mode</i>: The same as in normal operation, with, in addition, the possibility of releasing the buzzer relay even if the event is still present. The time delays are: <ul style="list-style-type: none"> <li>. Duration of maintenance: Minimum time of activation, adjustable from 0 to 900 seconds.</li> <li>. Automatic release: Time adjustable between 15 and 900 seconds, beyond which the buzzer relay is automatically released.</li> <li>. Reactivation: Time adjustable between 15 and 900 seconds, beyond which the buzzer relay is reactivated.</li> </ul> </li> </ul> <p><b>Alarm Relay Controls</b></p> <ul style="list-style-type: none"> <li>- Logic equations of up to 4 levels of parentheses by the logic operators OR, AND, NOR, NAND. The result of the equation controls the relay.</li> <li>- Polling Operations (x over y): There must be at least “x” events over the total of “y” to activate the relay. Optionally, the user may define whether a failure is considered an event in the same category as an alarm.</li> </ul>
H.	Alarm relay terminal block. CRT contacts, 2A - 250 VAC or 30 VDC.
J.	Integrated siren (optional).
K.	Power supply sector block.
L.	Integrated flash (optional).
M.	Microcontroller PCB.
N.	Area of 12 + 6 cable glands (connections towards the exterior).
P.	Grounding terminals to connect cable shields for digital and analog connections.
Q.	Terminal block for lines 1 to 8 (or 1 to 4 as per version). Refer to the <i>Digital lines</i> paragraph on page 40.
R.	Connector for the connection of a remote release (dry contact NO.)
S.	Power supply sector input.
T.	Protective secondary ground connection.
U.	USB programming port.
V.	Programming switch.
W.	CR2032 lithium battery.
X.	RS485 Digital Output Module. See 12.

### 4.1.3 Microprocessor card view

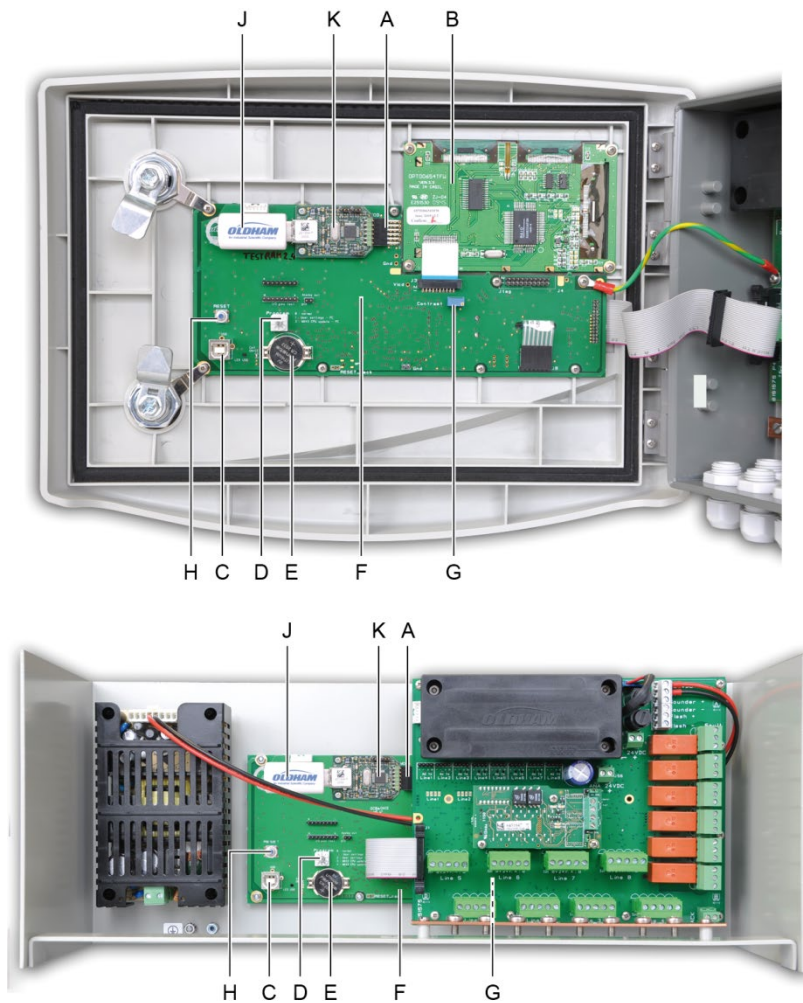



Figure 10: internal view, wall-mounted and rack-mounted versions – microprocessor cards and display.

Rep.	Function
A.	USB key connector.
B.	LCD graphic display card.
C.	USB programming port.
D.	Programming (or mode) selector. <ul style="list-style-type: none"> <li>0. <i>MX 43</i> in normal operation.</li> <li>1. Transferring configuration from a PC to the <i>MX 43</i>.</li> <li>2. Transferring configuration from a USB key to the <i>MX 43</i>.</li> <li>3. Updating the <i>MX 43</i> internal software via PC.</li> <li>4. Updating the <i>MX 43</i> internal software via USB key.</li> </ul>
 <p>Once the unit configuration or update is complete, always set the selector in the "0" position.</p>	
E.	CR2032 lithium battery. Safeguards the preservation of the records and real time clock in case of total power failure. Autonomy of approx. 450 days with the power off. At each battery change, power the <i>MX 43</i> .
F.	Microcontroller PCB.
G.	Regulating LCD contrast.
H.	Microcontroller zero reset button. Press this button to reset the controller.
J.	Optional USB key. Allows you to save <i>MX 43</i> input (measurements, alarms, etc.) or to transfer files from the USB key to the <i>MX 43</i> (transferring configuration or updates to the <i>MX 43</i> 's onboard software). In order to avoid data loss, TELEDYNE OLDHAM



Rep.	Function
	SIMTRONICS recommends using keys offered through its own commercial services. A 4Go key can record approximately 18 months of information from an <i>MX 43</i> comprised of 32 detectors with a sampling frequency of 2 seconds and up to 100 events per day and per detector.
K.	USB collection module.

## 4.2 Front Plate

This has the following aspect:

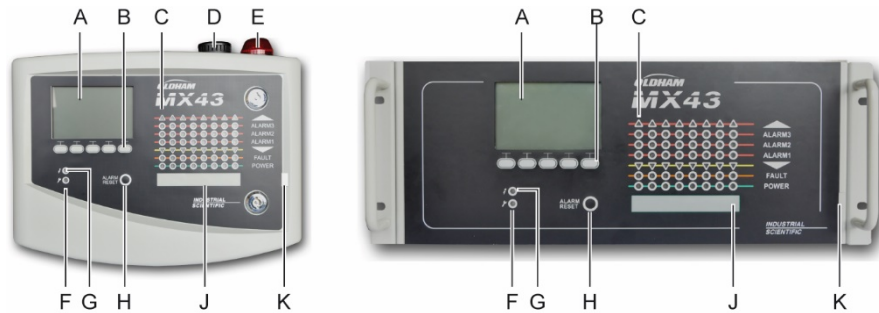

Figure 11: Front plate of the MX 43 in wall-mounted and rack-mounted versions.

### 4.2.1 LCD

The display shows the measurements or the menus of the parameter setting, and an inverse video display indicates that the module that is currently displayed has an active alarm.

The details of the displays are the subject of the chapter *Menus*, on page 45.

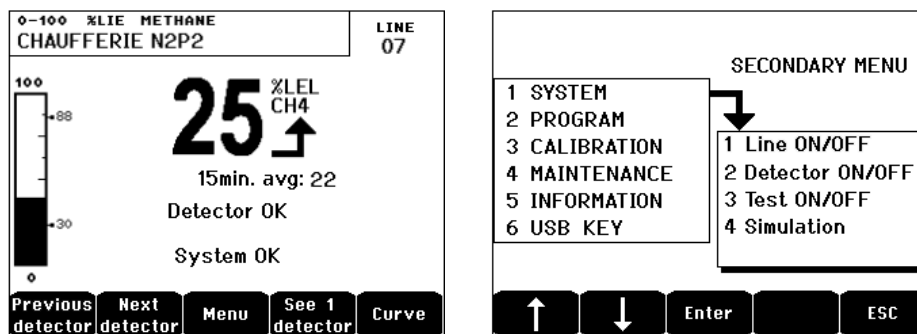

Figure 12: Example of a measurement display (screen) or parameter setting display (menu on the left).

Refer to the paragraph *Display in normal mode* on page 46 for information about what may be displayed on the screen.

### 4.2.2 Contextual Keys (B)

The function of each of the 5 keys indicated in the lower part of the display changes depending on the page displayed.

### 4.2.3 Zone Status Indicators (C)

Eight bars of 7 indicators each are displayed on the controller.

The 4 bars to the right are not operative on a 4-line MX 43.



Each bar represents a geographic area of the complete installation and not the 4 or 8 lines of the MX 43.

Each bar displays the status of the group of detectors of the pertinent zone as follows:

Icon	Function
▲	<p>Orange indicator of high-range excess (OVS: overscale, high-range excess). This value is adjustable up to 110% of the range.</p> <ul style="list-style-type: none"> <li>- Off: The measurement is lower than the OVS value programmed.</li> <li>- Lit: The measurement is higher than the OVS value programmed. The alarm relays are activated in accordance with the program. In parallel, the display indicates « &gt; ».</li> </ul> <p>OVS resetting is done manually and is only possible if the value measured drops below the programmed value.</p> <p><b>Management of "Clear doubt"</b></p> <p>The <i>Clear doubt alarm</i> is only applicable to the detection of explosive gases in a range of 0-100%LEL, and is subject to the decision of the operator. Upon the detection of a concentration of gas higher than 100% LEL, the LCD indicates a measurement blocked at 100% LEL and the message &gt; 100% LEL. The message <i>Strong concentration. Resetting by an authorized person in the maintenance menu</i> is displayed. The OVS and FAILURE indicators are activated. The alarm can only be deactivated by stopping the detector via the maintenance menu once the gas level decreases below this limit.</p>
ALARM 3	Red indicators of alarm status:
ALARM 2	- Off: Measurement lower than the threshold defined.
ALARM 1	<ul style="list-style-type: none"> <li>- Solid light: at least one of the gas detectors is in alarm mode. Acknowledgment is programmed in automatic mode or has already been requested through use of the Alarm reset button on the front panel.</li> <li>- Flashing light: at least one of the gas detectors is in alarm mode. Acknowledgment is programmed in manual mode.</li> </ul> <p>The alarm relays will be activated in accordance with the programming.</p>
▼	<p>Orange indicator of low-range excess (UDS: Under scale, low-range excess). This value is adjustable from 0-10% of the range.</p> <ul style="list-style-type: none"> <li>- Off: The measurement is higher than the UDS value programmed.</li> <li>- Lit: The measurement is lower than the UDS value programmed. The alarms of the relays are activated in accordance with the programming. In parallel, the display indicates « &lt; ».</li> </ul> <p>UDS resetting is automatic once the failure disappears.</p>
FAULT	<p>Orange failure indicator</p> <ul style="list-style-type: none"> <li>- Off: No failing module or detector.</li> <li>- Fixed light: Communication problem with one of the modules or invalid detector measurement, that is to say either below -10% of the range or above 110% of the range.</li> <li>- Blinking light: Controller in <i>maintenance</i> mode (test, calibration).</li> </ul> <p>The Failure reset is automatic once the failure disappears.</p>
POWER	<p>Green start/stop indicator for the detectors/modules of the zone.</p> <ul style="list-style-type: none"> <li>- Off: All the detectors of the zone are stopped.</li> <li>- Fixed light: At least one of the detectors of the zone is working.</li> <li>- Blinking: The information details of one of the detectors/modules of the zone are actually displayed on the LCD screen.</li> </ul>

## 4.2.4 Flash and siren (D and E)

### Siren (D)



Located in the upper portion of the box, the siren is optionally available solely in the wall-mounted version. It is always discontinuous and is configured via the COM 43 application.

### Flash (E)

Located in the upper portion of the box, the flash is optionally available solely in the wall-mounted version. It is configured via the COM 43 application.

## 4.2.5 Status indicators (F and G)

These two indicators reflect the status of the MX 43.

Icon	Function
	<p>Green general start/stop indicator denoting the power supply status</p> <ul style="list-style-type: none"> <li>- Fixed: Correct power supply.</li> <li>- Off: No power supply.</li> <li>- Blinking: Power supply problem (absence of power in the sector or problems in the internal battery pack).</li> </ul>
	<p>Failure/maintenance orange indicator</p> <ul style="list-style-type: none"> <li>- Off: No failure detected.</li> <li>- Fixed light: Presence of some failure (controller, detector, communication, memory). The alarm goes off automatically once the failure is cleared.</li> <li>- Blinking light: MX 43 in maintenance mode (test, calibration).</li> </ul>

## 4.2.6 Alarm reset Key (H)

Pressing this key has the effect of releasing the internal buzzer and the alarms that it enables. This key has the same function as the remote release key that may be connected; see paragraph on the *Remote Acknowledgement connector* on page 41.

## 4.2.7 Zone Identification (J and K)

Pull the tab to write in the zone labels.



Figure 13: Pulling the tab.

## 4.3 Alarm and Relay Thresholds

Alarm thresholds, relay programming, the management of time delays, and methods of release are controlled over the COM 43 application.

Note: It is possible to modify an alarm limit via the *Programming* menu of *MX 43*.

### 4.3.1 Parameters of Detector alarms

It is possible to program the following for each detector:

- 3 alarm thresholds.
- Each value is configurable in increasing or decreasing values.
- Each alarm is configurable as an instantaneous and/or average alarm of 15 to 480 minutes.
- Each alarm has an adjustable lag of 0 to +3% (or -3% for a negative alarm) for the value of the range of measurement, by pitch steps of 1%.
- A high-range excess alarm (OVS: *over scale*).
- A UDS low-range excess alarm (UDS: *underscale*).
- A "clear doubt" alarm (in the case of explosive gas detectors).

The alarms may be programmed for automatic or manual release (except OVS, UDS, and clear doubt).

### 4.3.2 Automatic deletion of alarms

The release (resetting) of alarms does not require any intervention. The management of alarms (relays, indicators, buzzer) is carried out according to the following table:

Event	Message screen	Alarm relay (normal)	Alarm Relay (buzzer)	LED alarm	Internal buzzer
Appearance	AL (1,2,3) and inverse video of the detector	Activated	Activated	Fixed light:	Activated
Press <i>alarm reset</i>	AL (1,2,3) and inverse video of the detector	Activated	Deactivated	Fixed light:	Deactivated
Disappearance	Normal display	Deactivated	Deactivated	Off:	(a)

(a): Manual release compulsory to stop the internal buzzer.

(b): Automatic deactivation upon alarm disappearance, even if no release has been requested before the alarm disappearance.

(c): If programmed

Table 2: Automatic deletion of alarms.

### 4.3.3 Manual deletion of alarms

Release (resetting) by the operator is compulsory. The management of alarms (relay, indicator,

buzzer) is carried out according to the following table:

Event	Message screen	Alarm relay (normal)	Alarm relay (buzzer)	LED alarm	Internal buzzer
Appearance	AL(1,2,3) and inverse video of detector	Activated	Activated	Blinking light	Activated
Release activated	AL(1,2,3) and inverse video of the detector	Activated in the presence of an event	Deactivated	Fixed light if an event is present	Deactivated
	AL(1,2,3) and inverse video of the detector	Deactivated if the event disappears	Deactivated	Off if an event disappears	
Disappearance	Normal display	Deactivated (1)	Deactivated	Off (1)	Deactivated (1)

(1): compulsory after manual release.

Table 3: Manual alarm deletion.

### Internal relays and buzzers

The operating mode of relays and optional visual and sound alarms (Figure 11, F and G) is configured over the COM 43 application.

- Relays: 5 alarm relays (R1 to R5) are common to all the lines.
- The internal buzzer is common to all the alarms of all the lines: it is activated on the appearance of an event (failure or alarm). The common failure relay is active in parallel. The sound frequency of the internal buzzer differs in accordance with the alarm threshold. High alarm thresholds have a faster sound frequency, thus making it possible to distinguish the alarm level. The internal buzzer can be deactivated by the internal programming menu or the COM 43 application.

Note: The failure relay cannot be programmed via the COM 43 application, but is activated on the occurrence of a failure.

## 4.4 USB Key Operation

### 4.4.1 Transferring configuration to the MX 43



The files found on the USB key must not be modified. For example, if a "firmware", "data" or "events" file is modified on a computer it will no longer appear on the MX 43 when the key is read. Only files labeled "configxxxx" can be modified for ease of recognition. When changing a file name, the name can contain no more than 19 characters and no spaces. Only the letters A(a) to Z(z), the numbers 0 to 9 and special characters \$ % ' - \_ @ ~ ` ! ( ) { } ^ # & may be used. If other characters are added, the MX 43 will not be able to read the file.

A copy of the MX 43 configuration is automatically saved on the USB key (Figure 10, ref. A) when it is plugged in. The configuration file contains all of the input needed to completely

configure the *MX 43*. It can be copied and transferred to another *MX 43* for identical configuration if needed. Follow the steps below

- Set the programming selector (Figure 10, ref. D) to **2**.
- Press the *Reset* button (Figure 10, ref. H).
- After restarting the *MX 43*, the screen will show the configuration files present on the USB key.
- Select the file to be transferred from the USB key and press *Upload*.
- When the confirmation message appears, press *Enter* to confirm the transfer. Pressing on *Escape* will exit the screen without transferring the configuration.
- The *Programming in progress* message will appear, followed by *Transfer successful*. Position the programming selector (Figure 10, rep. D) to **0**. The *MX 43* will then restart using the new uploaded configuration file.

#### 4.4.2 Transferring internal software to the MX 43

A copy of the internal software is automatically saved on the key (Figure 10, ref. A) when it is plugged in. The internal software file contains the application which permits *MX 43* operation. To upload the file to the *MX 43*. Follow the steps below:

- Set the programming selector (Figure 10, ref. D) to **4**.
- Press the *Reset* button (Figure 10, ref. H).
- After restarting the *MX 43*, the screen will show the application versions present on the USB key.
- Select the file to be transferred from the USB key and press *Upload*.
- When the confirmation message appears, press *Enter* to confirm the transfer. Pressing on *Escape* will exit the screen without modifying the application.
- The *Programming in progress* message will appear, followed by *Program updated successfully* and *Transfer successful*. Position the programming selector (Figure 10, ref. D) to **0**. The *MX 43* will then restart using the new uploaded application.

#### 4.4.3 Using the MX 43 input files on a PC

##### Ejecting the USB key

Never remove the USB without following the procedure below: You could lose all of the data on the USB key, and your files will not be transferred. Follow the steps below:

- On the home screen, select *Menu > 6 USB key*. Enter the password, select *1. Configuration > Saving* and select *Stop*. Press *Enter*.
- The message *Do not remove the USB key* will be displayed. Wait for the menu to appear before removing the key.

##### Using the data (data files)

- On a computer, open a .csv file **data** in *Excel™* and convert the data that are separated by commas (see the following example).
- Click on column A and then from the menu bar, select *Data > Convert*. Click on *Delimiter > Next > Separator – Comma > Next > Data format – Standard > Finish*.

- The first 10 lines of the table contain information about the *MX 43*.
- Lines *Detector name* to *Last sensor replacement* contain information about the configuration of the first sensor. The following blocks contain information about each of the individual sensors connected to the *MX 43*.
- Further down, there is a table grouped together. Each line contains data pertaining to the sensors connected to the *MX 43*. The data are:
  - Table headings: name of the line, type of gas, unit of measurement.
  - On every line of the table: timestamp and average values for the timestamp indicated. The time increment is determined by the defined sampling frequency. See *Sampling Rate* on page 55.

Time/Detector	CHAUFFERIE2	BRULEUR-	Line4	Line5	Line6	Line7	Line8
Gas	CH4	CH4	CH4	CH4	CH4	CH4	CH4
Unit	%LEL	%LEL	%LEL	%LEL	%LEL	%LEL	%LEL
	14:23:58	13	13	13	13	13	12
	14:24:00	13	13	13	13	13	12
	14:24:02	13	13	13	13	13	12

Figure 14: excerpt of a data file.

### Using data (events file)

- On a computer, open the .csv file **events** in *Excel™* and convert the data that is separated by commas (see the following example).
- Click on column A and then from the menu bar, select *Data > Convert*. Click on *Delimiter > Next > Separator – Comma > Next > Data format – Standard > Finish*. Maximize column A.
- The first 10 lines of the table contain information about the *MX 43*.
- Lines *Detector name* to *Last sensor replacement* contain information about the configuration of the first sensor. The following blocks contain information about each of the individual sensors connected to the *MX 43*.
- Further down, there is a table grouped together. Each line contains data pertaining to the sensors connected to the *MX 43*. The data are:
- Table headings (*Name of detector, Alarm, Type of alarm, Time, Date*).
- For each line of the table, the corresponding event is listed.

Evenement	alarmes	type	temps	date
Intitulé détecteur	UDS	MARCHE	02:42:13	25/05/2013
CHAUFFERIE2	UDS	MARCHE	02:42:13	25/05/2013
BRULEUR-	UDS	MARCHE	02:42:13	25/05/2013
Line4	UDS	MARCHE	02:42:13	25/05/2013
Line5	UDS	MARCHE	02:42:13	25/05/2013
Line7	UDS	MARCHE	02:42:13	25/05/2013

Figure 15: excerpt of the events file.

# **MX 43**

ANALOG AND DIGITAL CONTROLLER  
USER GUIDE





## 5 Digital Modules

*This chapter presents the digital modules that may be installed on the MX 43 lines.*



The details of module connection are given on page 37.





Digital modules are configured via the COM 43 application.

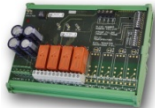

The modules delivered in a cabinet are already connected and configured ex works. Removing or adding modules, MX43L version only, requires reprogramming the MX43 control unit and reconfiguring the modules (addressing and end-of line resistance correction). See Addressable Digital Modules, page 27.

### 5.1 Addressable Digital Modules

These modules are connected on each of the available 4 or 8 lines of the MX 43, up to a limit of 32 modules on a version of 8-lines or 16 modules on a 4-line version. The following table regroups the available modules:

Type of module	Illustration	Page
Digital gas detector (OLCT 10N, OLCT 80, iTrans 2).		-
Output module, 4 relays with 2 additional logic inputs		30
Output module, 8 relays with 2 additional logic inputs		30
Module with 8 analog inputs		33
Module with 16 logic inputs		32

Type of module	Illustration	Page
Module with 4 analog 4-20mA outputs and 2 additional logic inputs		34

Table 4: Addressable digital modules.

## 5.2 RS485 Transmission

### 5.2.1 General Topology of RS 485 Network

The digital modules are linked by 2 twisted cable pairs of 4 x 0.22 m<sup>2</sup> minimum, type MPI-22A, nominal impedance of 100 Ohms. This cable carries the RS485 (A and B) signal on one pair and the power supply of the modules (0–24 VDC) connected to the line on the other pair. Shielding necessarily links all the modules to the terminal block of MX 43.

The + 24 VDC, 0V, A, B terminals are respectively connected to +24VDC, 0V, A, B terminals of the other modules on the line and then to the connector of the corresponding line on the controller. The cable shielding must be connected to the grounding rod of the MX 43.

At the end of the busbar, the 120-Ohm end of line resistor (EOL RESISTOR/RESISTANCE F.D.L) must be activated (whatever the last module).



No portion of the bare end of the terminal wires should be visible. For protection against any electromagnetic disturbances, the data as well as screen wires (or braids) must be cut as short as possible.

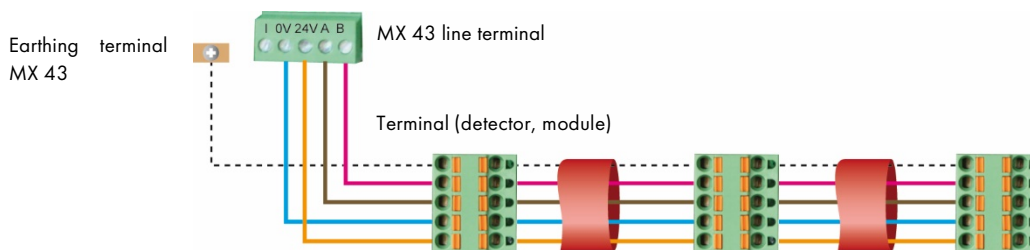

Figure 16: Principle of connecting modules to a MX 43 line.



The incorrect installation of the cables or cable glands can cause measurement errors or a malfunctioning of the system.

Do not lay the cables close to equipment such as engines, transformers, or lines generating important magnetic fields.

It is recommended to always ensure a distinct separation between these cables and the cables of other circuits.

## 5.3 Configuration of Communication

### 5.3.1 Module Address

All the digital modules on a line must be identified by a unique address.

Switches 1 to 5 of the configuration block of each module make it possible to establish an address number (1 to 32) in binary mode.

In the illustration to the right, the address 9 (10010) has been defined.

The *Addressing Table* below lists the possible combinations.

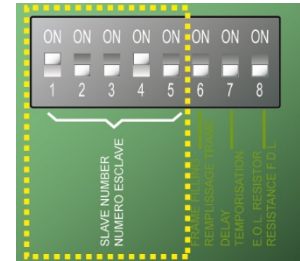

Figure 17: Switches of address configuration.

Module address	Switches (On: 1; OFF: 0)				
	1	2	3	4	5
1	1	0	0	0	0
2	0	1	0	0	0
3	1	1	0	0	0
4	0	0	1	0	0
5	1	0	1	0	0
6	0	1	1	0	0
7	1	1	1	0	0
8	0	0	0	1	0
9	1	0	0	1	0
10	0	1	0	1	0
11	1	1	0	1	0
12	0	0	1	1	0
13	1	0	1	1	0
14	0	1	1	1	0
15	1	1	1	1	0
16	0	0	0	0	1

Module Address	Switches (ON = 1; OFF = 0)				
	1	2	3	4	5
17	1	0	0	0	1
18	0	1	0	0	1
19	1	1	0	0	1
20	0	0	1	0	1
21	1	0	1	0	1
22	0	1	1	0	1
23	1	1	1	0	1
24	0	0	0	1	1
25	1	0	0	1	1
26	0	1	0	1	1
27	1	1	0	1	1
28	0	0	1	1	1
29	1	0	1	1	1
30	0	1	1	1	1
31	1	1	1	1	1
32	0	0	0	0	0

Table 5: Addressing table (address depends on switch positions).

Remarks:

- The physical address of a module (1 to 32) must be identical to the address stated on the configuration program COM 43 in the controller.
- During module replacement, all the configuration switches of a new module must be positioned in the same configuration as those of the previous module.
- The 6 switches (FRAME FILLING/REPLISS TRAME) must be set to OFF and the 7 switches (DELAY/TEMPORISATION) must be set to ON (options unused).
- An analog-input module systematically takes 8 addresses.

### 5.3.2 End of line Resistor

Solely for the last module of each line, set switch no.8 (EOL RESISTOR/RESISTANCE F.D.L.) to ON or set the jumper of the analog input PCB to *Closed*.

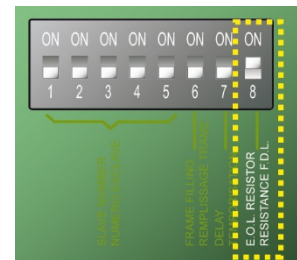

Figure 18: End of line resistor switch in position "ON".

## 5.4 Relay modules

### 5.4.1 Function

This digital module, available in two versions, allows for the management of:

- 1 to 4 relay outputs;
- Or 1 to 8 relays.

In addition, it has 2 logic inputs.

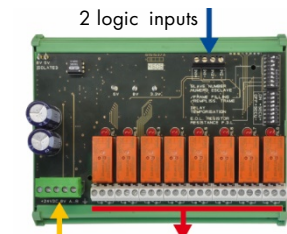

Figure 19: 8-relay module.

### 5.4.2 Introduction

Ref..	Description
A.	Connector for 2 logic inputs.
B.	Configuration switches of the module (digital address, delay, and end of line resistor).
C.	Switches for relay configuration.
D.	Power supply and digital network connector.
E.	Programmable relay (4 or 8).
F.	Relay status indicator.
G.	Connection terminal.

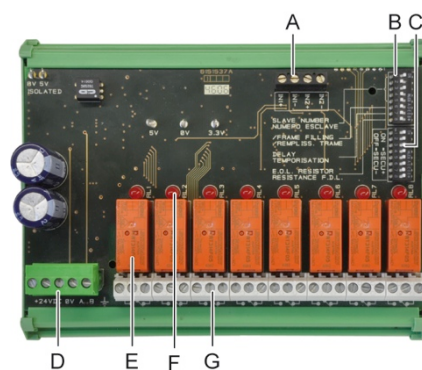

Figure 20: 8-relay module.

#### A – Logic input connectors

Each of these two terminals (Figure 20, A) may be connected to a voltage-free contact as per **Erreur ! Source du renvoi introuvable..** There is no alarm when the contact is open.

## B – Module configuration switches

These switches are set according to the following table.

Term	Symbol
<i>Slave number</i> Numéro esclave	See details in the paragraph <i>Module Address</i> on page 29.
<i>Frame filling</i> Remplissage de trame	Factory settings. Do not modify.
<i>Delay</i> Temporisation	Factory settings. Do not modify.
<i>E.O.L Resistor</i> Résistance F.D.L.	See details in paragraph <i>End of line Resistor</i> , on page 30.

**Table 6: Relay module configuration switches.**

## C: Relay configuration switches

The output status of each relay depends on the configuration of the switch block (Figure 20, ref. C). Set the switch to ON (energized) or OFF (de-energized) according to the safety type desired; each switch acts on the relay having the same number (switch 1 acts on relay 1). The contacts are represented when no power and no alarm apply.

For the 4-relay module, only switches 1 to 4 are active.

## E – Programmable relays

In its maximum configuration, the MX 43 can manage 24 external relays (or 24 modules with 1 stated relay or 3 modules of 8, all stated relays). The relays are individually programmable. The operation of each relay depends on its configuration.

Each of the 6 detector events [AL1 - AL2 - AL3 – High-range excess – Low-range excess – Failure] can control one or several external or internal relays. Several events can be assigned to the same relay.

### *Setting of relay parameters*

The alarm limits governing the relays can only be set by the COM 43 application.

- **Normal:** Relay operation as per the normal management of an alarm. (The relay is launched only if the event exceeds the duration of the time lapse).
- **Buzzer function (releasable relays):** The same as in normal operation, with, in addition, the release of the relay even if the event is still present. The time lapses are:
  - Duration of maintenance: Minimum time of activation, adjustable from 0 to 900 seconds.
  - Automatic release: If activated, the time is adjustable between 15 and 900 seconds, beyond which the buzzer relay is automatically released.
  - Reactivation: If checked, time is adjustable between 15 and 900 seconds, beyond which the buzzer relay is reactivated.

### *Controls of the alarm relay.*

- Logic equations of up to 4 levels of parentheses by the logic operators OR, AND, NOR, and NAND. The result of the equation controls the relay.
- Polling operations (x over y). There must be at least “x” events over the total of “y” to activate the relay. Optionally, the user may define whether a failure is considered an event in the same category as an alarm.

### **F – Relay status indicator**

The status of each relay is visualized by a red LED (Figure 20, F):

- LED off: Coil not powered.
- LED lit: Coil powered.

### **G – Relay output connectors**

The normal resistive load of each contact is 2A / 250 V AC or 2 A / 30 V DC.

## **5.4.3 Connection**

Refer to chapter 6, on page 37.

## **5.4.4 Configuration**

Configured via the COM 43 application.

# **5.5 16-Logic Input Module**

## **5.5.1 Function**

This digital module allows the monitoring of 1 to 16 logic inputs by the MX 43.

In the 8-line version, the controller can manage a maximum of 32 logic inputs distributed, for example, either on 32 logic input modules with one input declared per module, or on 2 modules with 16 logic inputs each.

In the 4-line version, the controller can manage a maximum of 16 logic inputs.

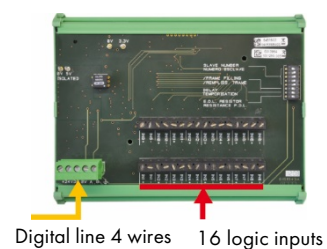

**Figure 21: Module with 16 logic inputs.**

## 5.5.2 Introduction

Ref.	Description
A.	Module configuration switches (digital address, delay, and end of line resistor).
B.	Power supply and digital network connector.
C.	Logic inputs 1 to 16.

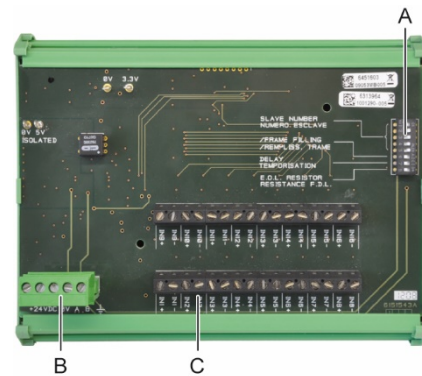

Figure 22: Module of 16 logic inputs.

### A – Module configuration switches

These switches are set according to the following table:

Term	Symbol
<i>Slave number</i> Numéro esclave	See details in the paragraph <i>Module Address</i> on page 29.
<i>Frame filling</i> Remplissage de trame	Factory settings. Do not modify.
<i>Delay</i> Temporisation	Factory settings. Do not modify.
<i>E.O.L Resistor</i> Résistance F.D.L.	See details in paragraph <i>End of line Resistor</i> , on page 30.

Table 7: Configuration switches of the *Logic input module*.

### C –Logic input connectors

Each of these 16 inputs can be connected to a voltage-free contact as per Figure 39. Input status is transmitted by the digital line to the MX 43. There is no alarm when the contact is closed.

## 5.5.3 Connection

Refer to chapter 6, on page 37.

## 5.5.4 Configuration

Configured via the COM 43 application.

## 5.6 8-Analog Input Module

### 5.6.1 Function

This digital module enables the monitoring of 8 analog (4-20 mA or Wheatstone bridge) inputs.

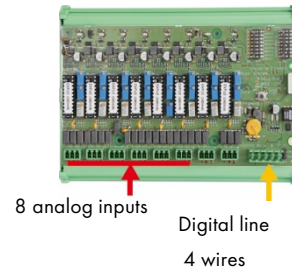

**Figure 23: 8-analog inputs.**

### 5.6.2 Introduction

Ref..	Description
A.	Jumper of configuration 4-20mA or a Wheatstone bridge.
B.	Sensitivity calibration.
C.	Zero calibration.
D.	Measuring point of each line.
E.	Reference 1.2 V for bridge calibration.
F.	Start/stop input switches not used, always in ON position.
G.	Lug 0V for 4-20mA calibration.
H.	PCB configuration switches (digital address, delay).
J.	Inputs no.1 to 8 (4-20mA or Wheatstone bridge as per. A).
K.	Filament current calibration (factory setting).
L.	4-20mA division strap in case of parallel operation of several analog detectors on the same line (application parking).
M.	Power supply and digital network connector.
N.	End of line resistor jumper. (raised position, EOL resistor connected).

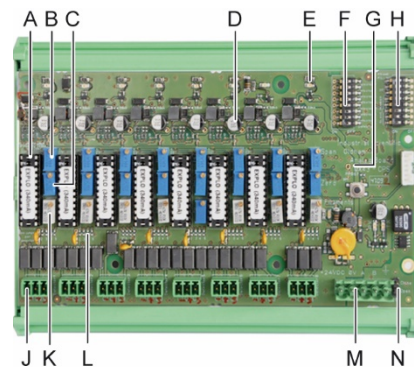

**Figure 24: Module of 8-analog inputs.**

### E – Module configuration switches

These switches are set according to the following table:

Term	Symbol
Slave number Numéro esclave	See details in the paragraph <i>Module Address</i> on page 29.
Frame filling Remplissage de trame	Factory settings. Do not modify.
Delay Temporisation	Factory settings. Do not modify.
E.O.L. Resistor Résistance F.D.L.	See details in paragraph <i>End of line Resistor</i> , on page 30.

**Table 8: Analog input module configuration switches.**



### 5.6.3 Connection

Refer to chapter 6, on page 37.

### 5.6.4 Configuration

Configured via the COM 43 application.

*Note related to manual calibration of the detectors connected to an 8-analog input module.*

#### 1. Zero calibration

Inject standard gas to obtain 4 mA. Place the multimeter between points E and D (Figure 24). If the value measured is different from 0 V, adjust C.

#### 2. Sensitivity calibration

After injecting the gas, place the multimeter between points E and D (Figure 24). If the value measured is different from 1.6 V, adjust B.

Should the adjustment value be different, calculate:

$$V = I \text{ (mA)} \times 0.10 \text{ (V/mA)}$$

Example: If the current is 12 mA, "V" must be equal to 0.8 V.

If point E is not on the module use point G and add 1.2V to the measurement

## 5.7 4-Analog Output Module

### 5.7.1 Function

This digital module delivers 1 to 4 independent analog values (4-20 mA outputs) opto-isolated from the values given by the MX 43, capable of being independently activated or deactivated:

- Activated: The 4-20mA signal varies depending on the input.
- Deactivated: The 4-20mA signal is blocked at 0 mA, whatever the input signal.

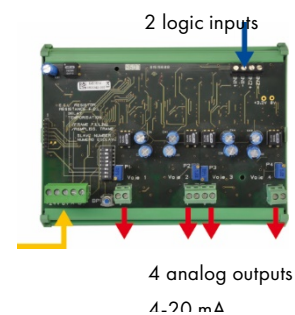

Figure 25: Principle 4-analog output module.

Several analog values may be associated to the same 4-20mA output authorizing the management of minimums, maximums, or averages from a group of detectors This module likewise has 2 logic inputs.

## 5.7.2 Introduction

Ref.	Description
A.	Connector for 2 logic inputs.
B.	Power supply and digital network connector.
C.	Module configuration switches (digital address, delay, and end of line resistor).
D.	Push-button. Pressing this button generates 20mA current in the output of each line.
E.	(E1 to E4) opto-isolated independent 4-20mA analog outputs.
F.	(F1 to F4) 20mA calibration in line output.

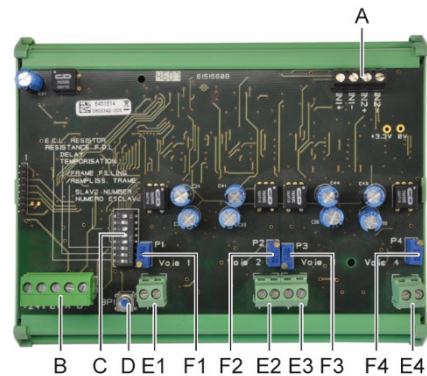

Figure 26: 4-analog output module.

### A –Logic input connectors

Each of these two terminal jacks (Figure 26, A) may be connected to a voltage-free contact in accordance with **Erreur ! Source du renvoi introuvable.** Input status is transmitted by the digital line to the MX 43.

### C – Module configuration switches

These switches are set according to the following table:

Term	Symbol
<i>Slave number</i> Numéro esclave	See details in the paragraph <i>Module Address</i> on page 29.
<i>Frame filling</i> Remplissage de trame	Factory settings. Do not modify.
<i>Delay</i> Temporisation	Factory settings. Do not modify.
<i>E.O.L. Resistor</i> Résistance F.D.L.	See details in paragraph <i>End of line Resistor</i> , on page 30.

Table 9: Analog output module configuration switches.

## 5.7.3 Connection

Refer to chapter 6, on page 37.

## 5.7.4 Configuration

Configured via the COM 43 application.

## 6 Wiring and Electrical Connections



Concerning versions in cabinet, see the specific chapter 14.

This chapter details the electrical connections of all the system components (MX 43, modules, additional equipment).

### 6.1 Controller Connection

The electrical connections must be carried out by qualified personnel in compliance with the different directives in force in the country of installation.



The MX 43 does not have a start/stop switch.

Certain voltage levels are capable of causing serious injuries or even death. It is advised to install the material and cabling before applying live voltage.

Since an incorrect or poor installation may cause measurement errors or system failures, it is necessary to strictly follow all the instructions in this manual in order to guarantee the proper operation of the system.

Cables with an operating temperature of up to 75°C-167°F must be used because the temperature inside the controller can reach 60°C-140°F.

#### 6.1.1 Access to terminal blocks

- **In wall-mounted version:** After unblocking the two locks, swing the front cover towards the left in order to access the cabling terminal blocks (A).
- **In rack version:** The terminal blocks are cabled from behind the controller (B).

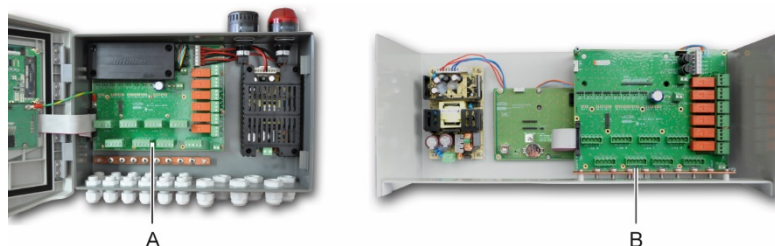

Figure 27: Access in wall-mounted version (left) and rack-mounted version (right).

## 6.1.2 Sector Power Supply

The MX 43 can be powered from a 110-240 V AC source at 50/60 Hz, 1.5 A max.

Check the nature of the current and the network voltage prior to any connection. The electrical connections must be carried out with the equipment disconnected.

The MX 43 must be protected upstream according to the local regulations.

In France for example: The MX 43 must be protected upstream by a bipolar circuit breaker with a type C response curve, size 4A. This circuit breaker must be included in the electrical installation of the building, in the immediate proximity of the MX 43, and be easily accessible to operators. It shall be marked as the cut-off device of the MX 43.

The sector power shall be connected to the terminal block as indicated in Figure 28. The ground conductor shall be connected to the ground terminal (B).

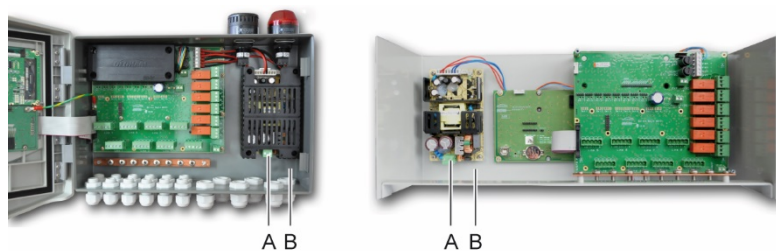

Figure 28: Connection of sector power in wall-mounted and rack-mounted versions.

## 6.1.3 External 24V DC Power Supply

The MX 43 can be powered from a 22 to 28 V AC source at 50/3.2 A, 1.5 A max. In this case, connect the 24VDC source to the corresponding terminal jack (Figure 29, A) respecting polarities. This jack is protected by Fuse F1.

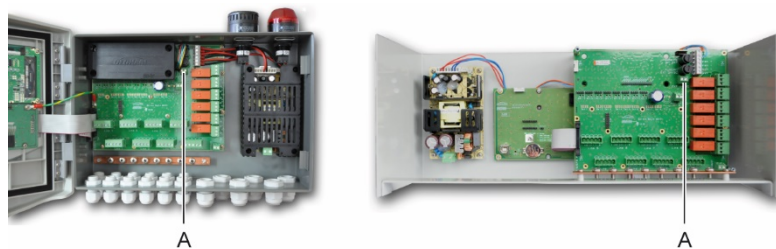

Figure 29: Connection of 24VDC external power supply (A).

The main power supply charges the internal pack. The external 110-240 VAC, 24 VDC and battery pack sources can be used simultaneously, as there is internal protection installed.

## 6.1.4 Integrated Backup Power Supply

The *MX 43* can be equipped with a 24-VDC NiMh battery pack that maintains power to the controller in the absence of the sector current or external 24VDC. The batteries are charged by the mains supply (110-240 VAC).

The battery pack requires continuous charging for 7 days before reaching its maximum capacity. Its autonomy depends on the *MX 43* configuration.

If the battery pack is not installed at delivery, proceed as follows:

1. Position and fix the battery pack (A) at the place indicated using the 4 screws supplied.
2. Connect the battery pack connector to the connector (B) of the PCB. A failsafe slot impedes any connection error.

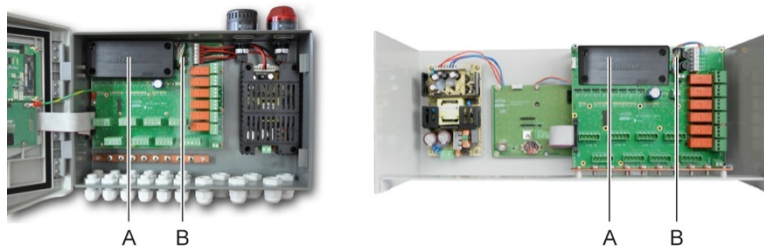

Figure 30: Positioning the battery pack.

## 6.1.5 Earthing

The *MX 43* is intended to be used in the parts of installations corresponding to the category of overvoltage II and pollution degree 2 as per EN/IEC 60947-1. In order to comply with this category of protection, it is absolutely necessary to connect the ground terminal (Figure 9, T). Moreover, the cable braids of the digital and analog lines shall also be connected to this ground terminal (Figure 31, A).

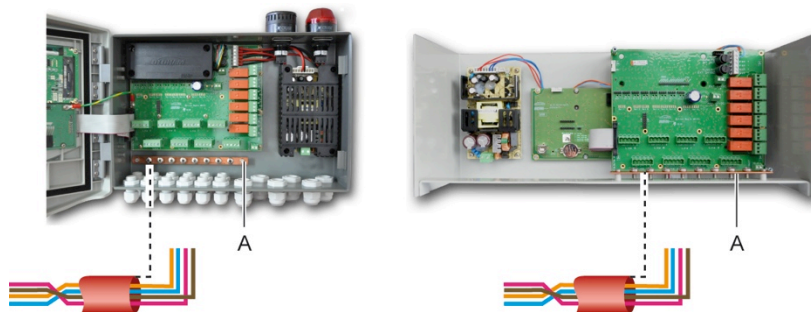

Figure 31: Ground and braid connection.

### 6.1.6 Digital lines

The cabling of the digital lines connecting the controller to the different modules deployed along the lines are the subject of the paragraphs *OLCTION Modules, 4- or 8-relay modules, 16-logic input modules, 8-analog input modules and 4-analog output modules* of this same chapter. It should be remembered that this cable comes in 2 twisted pairs of 4 x 0.22 m<sup>2</sup> minimum, type MPI-22A, nominal impedance of 100 Ohms.

### 6.1.7 Analog channels

For an analog 4-20mA detector connected directly on the MX 43 channels, please connect the detector as shown below.

"I" is the 4-20mA signal, 0 and 24V correspond to the power supply.

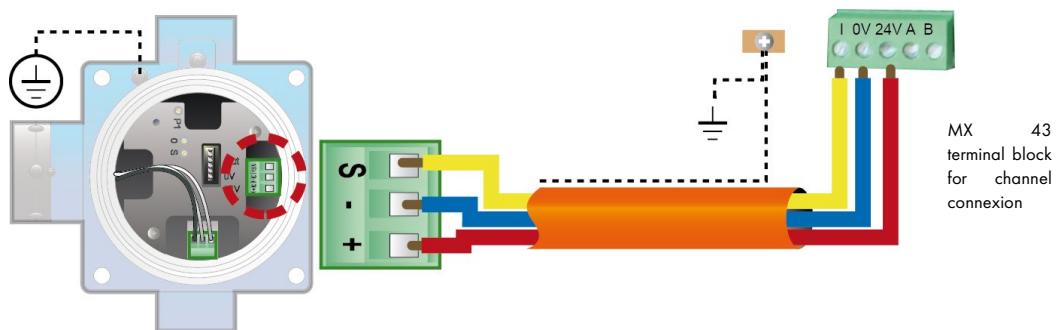

Figure 32: 4-20mA detector connected directly on the MX 43 channels.

Please see below the figure for the motherboard with position for channel connection and relays.

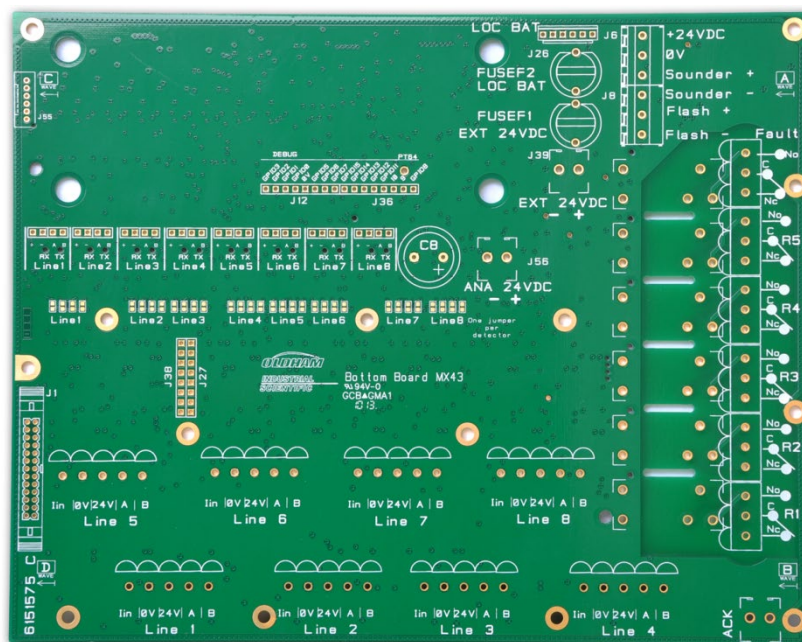

Figure 33: MX 43 Motherboard.

## 6.1.8 Internal alarm relays

The MX 43 has 6 relays of the following internal alarms:

Output	Function
R1	Relay of freely programmable function
R2	Relay of freely programmable function
R3	Relay of freely programmable function
R4	Relay of freely programmable function
R5	Relay of freely programmable function
Failure : (Default)	Non-programmable common relay, energized, activated upon the presence of a failure in the MX 43 (detector and/or module, increased internal temperature, transition to power supply from the backup battery pack, system anomaly, etc.). The deletion of this relay is automatic.

Table 10: Internal alarm relays.

The dry contacts (nominal resistive load of 2 A at 250 VAC, and 2 A at 30 V DC) of the 6 internal relays R1, R2, R3, R4, R5 and Default are deployed on the MX 43 motherboard on the R1, R2, R3, R4, R5 and Default connectors (Figure 34).

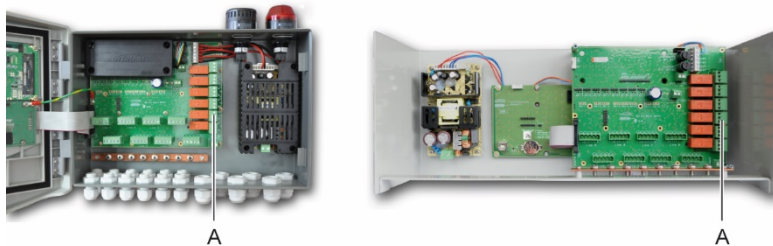

Figure 34: Internal alarm relay connectors (A).

Connect the external equipment to the control on terminal jacks R1 to R5.



The relay contacts are represented when no power applies to the MX 43. The position of the contacts (no alarm) once the MX 43 is powered will depend on the relay configuration (energized or de-energized). The relays are programmed via the COM 43 application.

## 6.1.9 Remote Acknowledgement Connector

If necessary, connect the ACQUIT (dry contact NO) terminal to a remote acknowledgement system.

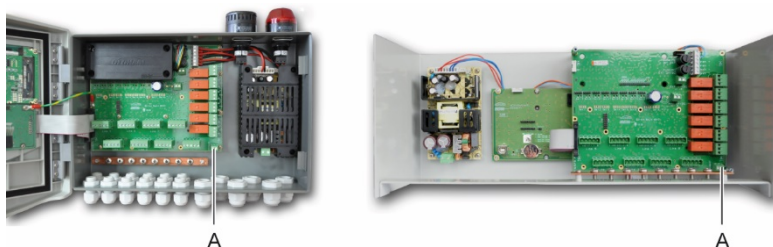

Figure 35: Remote acknowledgement connection (A).

### 6.1.10 Flash and Siren Control Connector

This connector, powered at 24VDC by the MX 43, allows power supply for a rotating light and a siren optionally available for the MX 43 in wall-mounted version. In the rack version, these connectors may be taken over to power a sound alarm (24VDC, 19mA max.) and a visual alarm (24 VDC, 40 mA max.). Ensure that the polarities are matched.

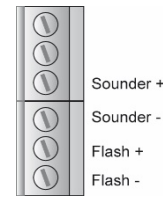

Figure 36: Flash and siren connector (A).

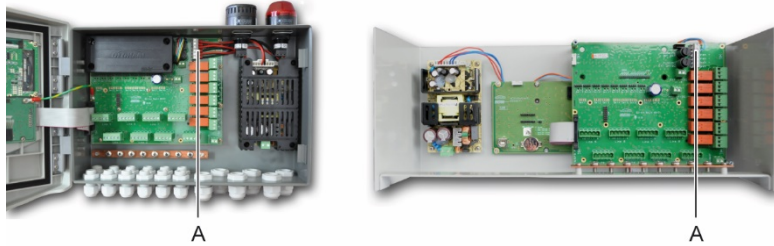

Figure 37: Location of the flash and siren connector (A).

## 6.2 4- or 8-Relay Modules

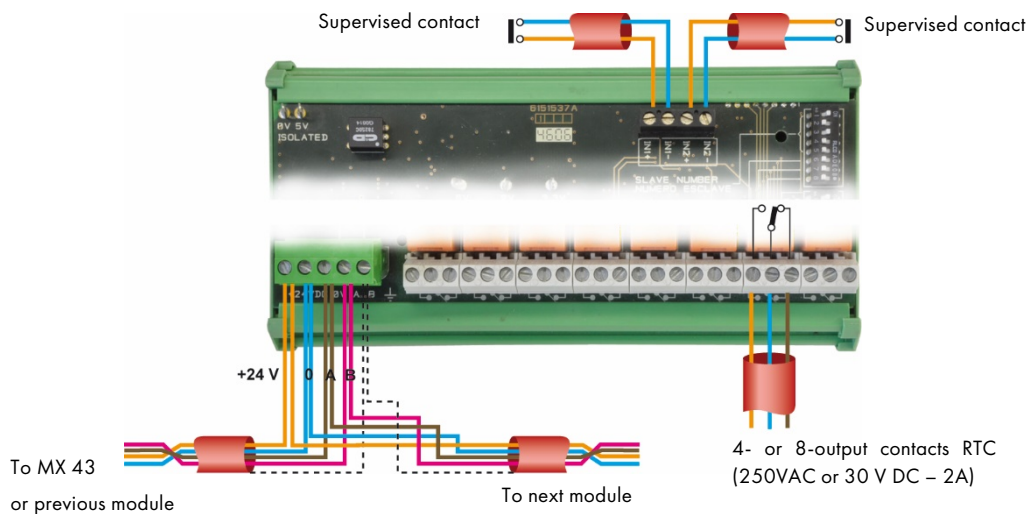

Figure 38: 4- or 8-relay module connections



If this module is the last on the line, do not forget to set the switch marked *EOL resistor/resistance FDL* to ON.



## 6.3 16-Logic Input Module

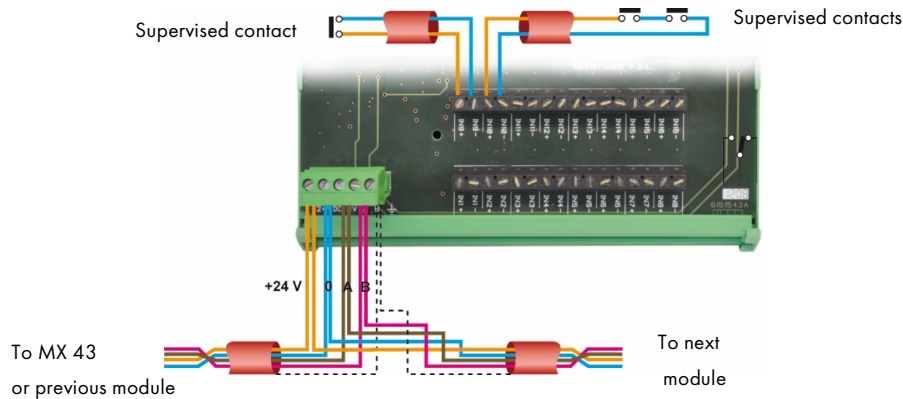
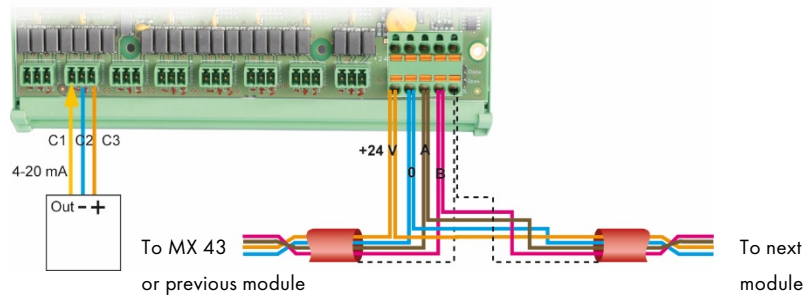

**Figure 39: 16-logic input module connections.**



If this module is the last on the line, do not forget to set the switch marked *EOL resistor/resistance FDL* to ON.

## 6.4 8-Analog Input Module



**Figure 40: Connections of 8-analog input modules for 1 4-20mA detector with 3 wires (explosive gas, toxicity detection).**

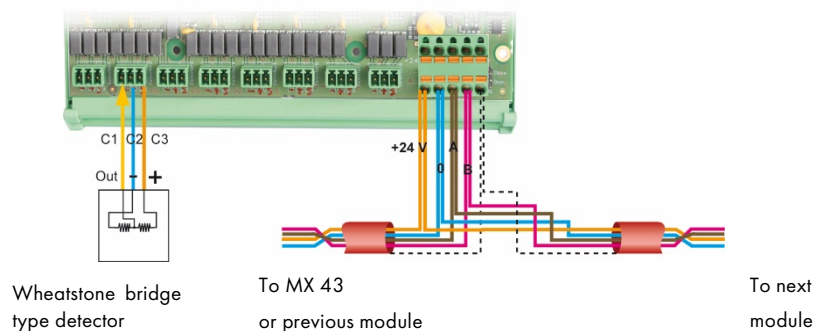

**Figure 41: 8-analog input module connections for an explosive gas detection detector of the Wheatstone Bridge CEX 300 or OLC type.**



If this module is the last of the line, do not forget to set the jumper marked *EOL Resistor* to *Closed* position.

## 6.5 4-Analog Output Module

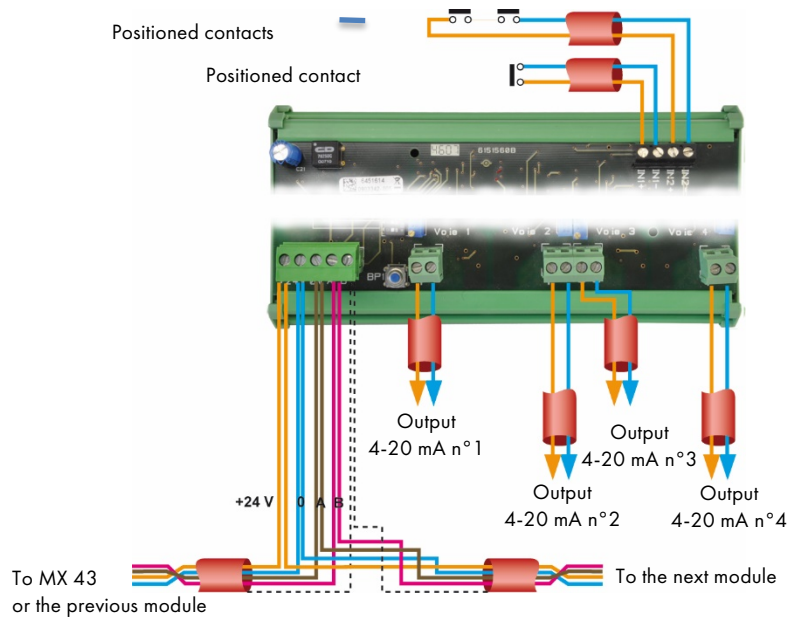

Figure 42: 4-analog output module connections.



If this module is the last of the line, do not forget to set the jumper switch marked *EOL Resistor/FDL resistance* to the ON position.

# 7 Menus

## 7.1 General Menu Tree

The following figure shows the general tree of the group of menus.

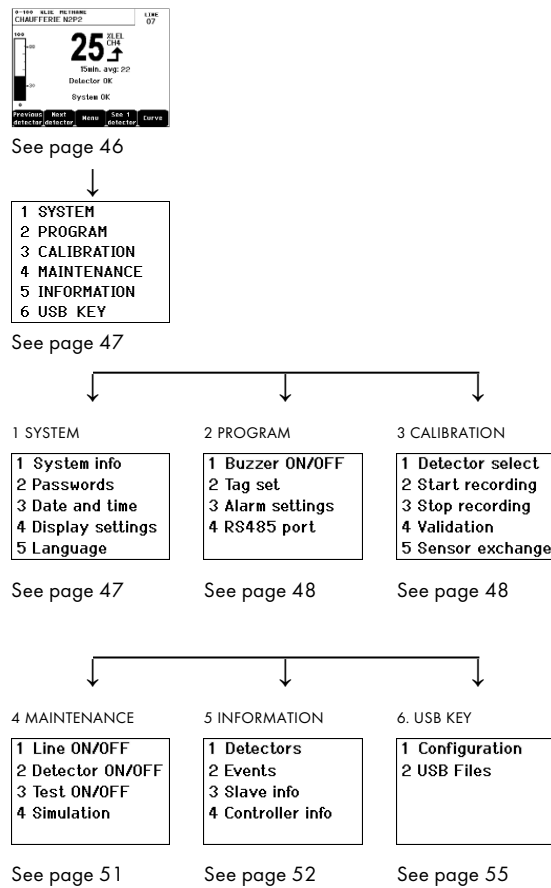

Figure 43: General menu tree of the MX 43.

## 7.2 Navigation Key Functions

Key	Function
↑↓	Vertical displacement in the selected menu block.
→←	Horizontal displacement between two menu blocks.
Enter	Validation of the selected line.
Escape	Return to previous screen.

Table 11: Function of the navigation keys.

## 7.3 Display in normal mode

### Measurement Display

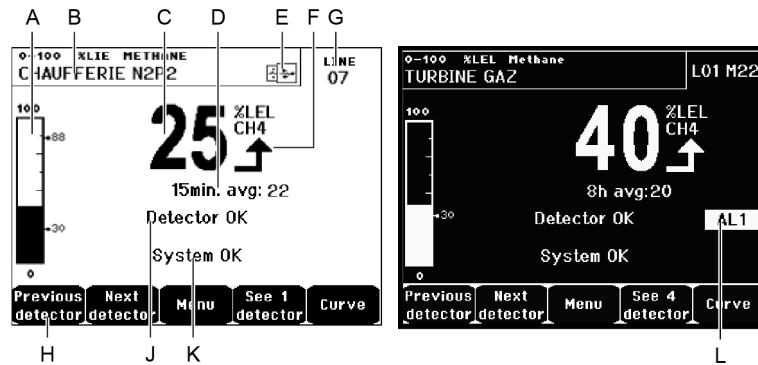

Figure 44: Example of the measurement display in normal mode and in inverse video.

Ref.	Significance
A.	Barograph with an indication of alarm limits.
B.	Measurement range, gas detected, and detector language.
C.	Value of the current measurement with the unit and gas detected.
D.	Value of the average measurement if this function has been activated via the COM 43 application and depending on the display settings (see <i>Display Settings</i> , on page 47).
E.	<p>USB Key symbol; see paragraph 6. <i>USB key</i> on page 55:</p> <ul style="list-style-type: none"> <li>■ Absent when the USB key is absent, and/or data recording has not started (menu 6. USB Key &gt; 1. Configuration &gt; Data Logging: OFF).</li> <li>■ Solid when the USB key is present and data recording has started (menu 6. USB Key &gt; 1. Configuration &gt; Data Logging: ON).</li> <li>■ Flashing when the key is absent and Data Logging option is set to ON.</li> </ul>
F.	<p>Indicator of measurement trend</p> <ul style="list-style-type: none"> <li>↑ Ascending tendency</li> <li>↓ Descending tendency</li> </ul>
G.	Address of digital detector on a digital line or channel number for a analog detector
H.	<p>Function keys.</p> <ul style="list-style-type: none"> <li>■ Previous detector: Display of measurements of previous detector; scanning of all the detectors on all the lines.</li> <li>■ Next detector: Display of measurements of next detector; scanning of all the detectors on all the lines.</li> <li>■ Menu: Display of main menu See paragraph "Main menu" on page 47.</li> <li>■ See 4 Detectors: Display of a group of 4 detectors (detector tag, barograph with indication of alarms, value of current measurement with unit and gas detected). Use the Page down or Page up keys to display all of the next 4 detectors; passage to the next zone is automatic.</li> <li>■ See 8 Detectors: Display of a group of 8 detectors (detector tag, value of current measurement with unit and gas detected). Other buttons similar to the selection. <i>See 4 detectors.</i></li> <li>■ See 16 Detectors: Display of a group of 16 detectors (detector tag, value of current measurement with unit and gas detected). Other buttons similar to the selection. <i>See 4 detectors.</i></li> <li>■ See 1 detector: Display in normal mode (Figure 44).</li> <li>■ Curve: Display of the measurement curves of the last 4 hours (Figure 45). The → and ← keys allow cursor displacement through the time scale. The vertical dotted line displays the concentration and time stamp of the point being considered. Escape: return to display of values.</li> </ul>
J.	Information on the detector status.
K.	Information on the MX 43 status.

- L. Zone of indication of activated alarms with blinking threshold display. The screen changes to inverse video (Figure 44, screen on the right).

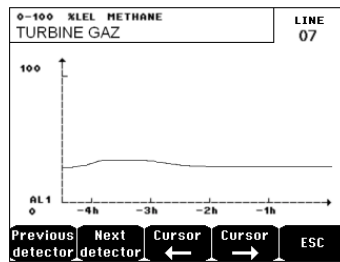

Figure 45: Example of a curve display screen.

## 7.4 Main Menu

This displays all the management menus of MX 43.

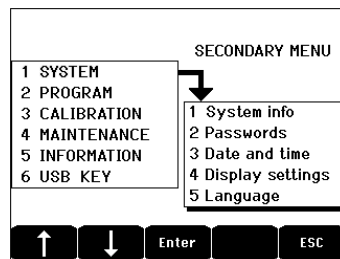

Figure 46: Main menu.

### 7.4.1 1. System

- 1. System Info Displays the version of the program, the *bootloader* (internal micro-software for loading the program), and the configuration, as well as software application verifications.
- 2. Passwords The controller is protected by two access codes, both set at 1000 by default upon leaving the factory. You can change the passwords in this menu via COM 43. The passwords are required each time you enter one of the menus that they protect.
 

**First-level password:** Authorizes access to the Calibration menu.

**Second-level password:** Authorizes access to the Programming, Calibration, and Maintenance menus. This password is also required before menu data are deleted.
- 3. Date and time Time stamp settings (year, month, day, hour, minute, second).
- 4. Display settings *Scrolling display*
  - OFF: the display is frozen on a selected detector.
  - ON: scrolls through detectors every two seconds.

*By zone*

- *ON*: displays all detectors assigned to the same zone (same bar of leds).
  - *OFF*: displays all connected detectors regardless the zone they are assigned to.
  - *Screen saver*
  - *OFF*: no screen saver.
  - *ON*: turns into the screen saver mode (displays Oldham logo) if no key is pressed for a certain period of time.
  - *Averaged value*
  - *OFF*: averaged gas measurement value is not displayed.
  - *ON*: displays the averaged gas measurement values over the last fifteen minutes or eight hours depending on the settings done with COM 43. Typically used when toxic gas detectors.
- 5. Language                      Selection of the display menu language.

## 7.4.2 2. Program

- 1. Buzzer On/Off                  Activates or deactivates the internal buzzer of the MX 43.
- 2. Tag set                              Allows for the modification of detector tags previously programmed via COM 43.
- 3. Alarm settings                  Allows for the modification of detector alarms previously programmed via COM 43.
- 4. Port RS485                      Configuration of Port RS485 (speed, parity, stop bits, slave number). This configuration is only useful if the *MX 43* is equipped with the RS485 communication card.

## 7.4.3 3. Calibration



If the measurement cell has changed, it is important to declare this through a menu no. 5 *Cell change*.

### 1. Detector select.

This menu enables the selection of detectors to be calibrated (calibration from MX 43 or on the detector).

- A. Display of information described by the COM 43 application: i.e., measurement range, gas detected, current detector ID and its type.
- B. Display for the current detector:
  - **Last passed calibration**: Date and time of the last calibration carried out and completed.
  - **Last sensor replacement**: Date and time of last cell change.

- **Wear rate:** Relation between the value of the standard gas and the value read (sensitivity measurement). A wear rate in excess of 100% entails a sensor replacement.
- C. Display of the address (digital detector) or line number (analog detector) to which the detector is connected.
- D. Selecting the detectors to be calibrated:
- Select one or several detectors using the **previous detector** or **next detector** keys.
  - On pressing the **Select** key, press **Cal gas** to enter its value by means of the  $\uparrow\downarrow$  keys. Validate by pressing **Enter**.
- Note: Only analog detectors that are not equipped with a local display can be calibrated from the MX 43 controller. For the other detectors, the menu "Sel. Detector" only makes it possible to put them in calibration mode so that they do not activate alarms during their manual calibration.*
- Press **Escape** to launch the procedure of recording the measurements on the detectors to be calibrated. Proceed to paragraph "2 Recording".
- E. Display the calibration gas.

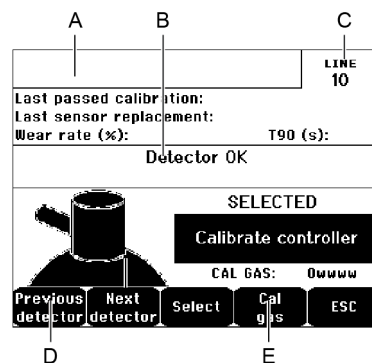

Figure 47: Example of the "Select detectors" screen.

## 2. Start Recording

- **Yes:** Launches the recording of calibration measurements for the selected detectors. From this moment onwards, all the calibration measurements are recorded for these detectors. "Start recording" is then displayed. The calibration of the detectors with the help of the standard gas can begin.

*For a detector in which the cell has been changed, it is important to adjust the detector locally to obtain a 4-20mA output corresponding to the detector range.*

*For detectors connected to the analog input module, perform the adjustments directly on the module (see page 35).*

**Attention:** During calibration, the standard gas must be injected for at least thirty seconds.

- **No:** Exits the recording procedure.

### 3. Stop recording

- **Yes:** Detector calibration having finished, this validates the end of calibration measurement recording for the detectors previously selected. From this moment onward, no calibration measurement is recorded. "Stop recording" is then displayed.
- **No:** Exits the end of the recording procedure.

### 4. Validation

This allows the adjustment and validation of zero and detector sensitivity once calibration is completed.

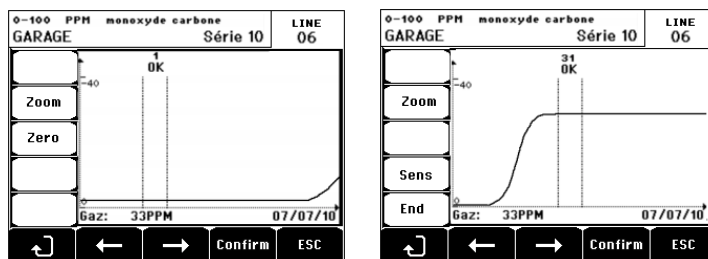

Figure 48: Adjustment of zero (left) and sensitivity (right).

### Operating mode

#### Detector selection

1. Select the detector to be calibrated with the help of the **Previous detector** and **Next detector** keys and press **Validate**.

#### Zero calibration

1. The **Zoom** command is active.
2. Select the area of interest of the curve with the **←** and **→** keys. Press **Zoom + up** to the activation of the Zero command. Adjust the position of the cursor so as to make the "OK" appear, in turn indicating that the range selected is sufficiently stable.
3. Press **↵** to select the term **Zero**.
4. Confirm the zero calibration by pressing **Validate zero**.
5. The term **Sens** (for sensitivity) is active from now on.

If sensitivity is not to be calibrated, press **↵** and **END**; until you see the message "Do you only want to calibrate zero for the detector?", then press **Validate calibration**. Only the zero calibration of the detector will have been carried out.

If sensitivity is to be calibrated, proceed directly to the following paragraph.

#### Sensitivity calibration

1. The **Sens** command is active.
2. Select the area of interest of the curve with the **←** and **→** keys. Press **Zoom + up** to the activation of the command Sens. If applicable, adjust the position of the cursor so as to make the "OK" appear, in turn indicating that the range that has been selected is sufficiently stable.



3. Confirm the sensitivity calibration by pressing **Validate Sens**.

#### *Record the calibration*

1. The message "Do you want to validate zero and detector sensitivity?" is displayed. Press **Validate calibration** to confirm the adjustment of zero and sensitivity or **Esc** to exit the procedure.
2. The detector is calibrated.

### 5. Sensor exchange

This function reboots the parameters (rate of wear, calibration date, internal parameters corresponding to the 4-20mA range, etc.) from the selected detector(s) following or in view of a change of cell.

#### *Detector Selection*

1. Select the detector(s) to be rebooted with the help of the **Previous detector**, and **Next detector** keys and press **Select**.

#### *Detector Rebooting*

1. Press Escape to launch the reboot of the selected cells.
2. Proceed next to the changing of the cell and then to a calibration of the corresponding detectors via the menus "1 Sel detectors", "2 recording", "End recording" and "4 validation".

## 7.4.4 4. Maintenance

### Access

Successively press the keys **Menus** and **Maintenance**.

#### 1. Line On/Off

Sets the line to stop (the line is not powered and the detectors are at stop; no event can be generated from then on).

#### 2. Detector On/Off

Sets the detector to stop (no event can be generated from then on) if it was not issuing an alarm or failure.

#### 3. Test On/Off

This allows for the verification of the proper operation of a detector. In this mode, recordings and alarm relays are suppressed.

#### 4. Simulation

Upon its selection, the message "The controller no longer ensures detection" is displayed.

- The controller no longer keeps account of inputs (detectors, logic inputs).

- The simulation measurements/status are initialized to the current measurement/status values. The relays, the internal buzzer, and the analog outputs remain in their current status.
- The screens, management of relays, outputs, etc. are those of Normal operation.
- The internal relay and the common default LED are activated.
- To change the value of a detector, use the ↓↑ keys to increase or decrease the measurement value simulated from -15% to 115%. For a logic input, use the ←→ keys to select the input, ↓↑ to select *Alarm* or *Alarm Off*.
- The banner of alarms does not appear.
- The events log indicates *Begin Simulation* and *End Simulation*.
- Exit the simulation mode by pressing the **End simul** key. Automatic release then occurs and resets the average values to zero. The current measurements are displayed once more.

## 7.4.5 5. Information

### 1. Detectors

This displays the main information on the detector (type, range, detected gas).

### 2. Events

Alarm events					
TURBINE GAZ	AL1	ON	08 01 10	11:40:01	
TURBINE GAZ	AL1	OFF	08 01 10	15:16:40	
Previous page	Next page	Last page	Delete	ESC	

Figure 49: Example of gas alarm files.

### 1. Alarm events

This displays, for each of the detectors concerned: detector ID, alarm type (AL1, AL2, AL3, AL1mean, AL2mean, AL3mean, OVS), status (activated = ON or deactivated = OFF) as well as the date and time of occurrence or of the release.

The letter "S" appears on the line if the events were obtained when the MX 43 was in simulation mode

**Delete** deletes all the data. Up to 512 events can be memorized. Beyond that, the most recent event deletes the oldest.

**Previous page**, **Next page**, and **Last page** access the corresponding pages of the file.

Message	Significance
AL1	Detector in level 1 alarm
AL2	Detector in level 2 alarm
AL3	Detector in level 3 alarm
OVS	Detector in OVS alarm

Message	Significance
AL1 M	Detector in alarm set to level 1 mean value
AL2 M	Detector in alarm set to level 2 mean value
AL3 M	Detector in alarm set to level 3 mean value

Table 12: Gas alarm file messages.

## 2. Fault records

This displays, for each detector concerned: event type (UDS = Under-scale), RANGE = measurement out of range, DEF = Failure, DOUBT = clear doubt), status (activated = ON or deactivated = OFF) as well as the date and time of appearance or release. This file cannot be deleted.

Message	Significance
UDS	The measurement is lower or equal to the value of the UDS programmed.
DEF	Detector failure (out of range, line cut, defective cell, etc.).
RANGE	Measurement out of range.
>> LEL	Concentration higher than 100% of LEL.

Table 13: Failure file messages.

## 3. Inputs and relays records

This displays, for each relay and logic input concerned: activated relay/input ID, type (REL = relay, EL = Logic input), its status (activated = ON, Deactivated = OFF) as well as the date and time of occurrence or release.

**Delete** allows for the deletion of this entire file. Up to 512 events can be memorized. Beyond that, the most recent event deletes the oldest.

**Previous page**, **Next page**, and **Last page** access the corresponding pages of the file.

Message	Significance
RELAY	Status change of the designated relay.
INPUT	Status change of the designated input.

Table 14: Relay and logic input file messages.

## 4. Working conditions records

This displays the actions carried out on the MX 43 (simulation mode, calibration mode, programming mode, release request, operation on internal battery), as well as the date and time of beginning and end of the event.

**Delete** allows for the deletion of this entire monitoring file. Up to 512 events can be memorized. Beyond that, the most recent event deletes the oldest.

**Previous page**, **Next page**, and **Last page** allow access to the corresponding pages of the file; each page can display a maximum of 8 lines.

Message	Significance
Lines On/Off	Start or stop the line
Detectors On/Off	Start or stop the detector
External ack.	Press the external acknowledgement button
MX 43 ack	Acknowledgement by the acknowledgement button on the front plate of MX 43
Simulation	Switch to simulation mode
Calibration	At least one of the detectors is selected in calibration mode.
Test detectors	Switch to test mode
Program	Programming done on MX 43
Time settings	Time settings on MX 43
Line 1 On/Off	Start or stop line 1
Line 2 On/Off	Start or stop line 2
Line 3 On/Off	Start or stop line 3
Line 4 On/Off	Start or stop line 4
Line 5 On/Off	Start or stop line 5
Line 6 On/Off	Start or stop line 6
Line 7 On/Off	Start or stop line 7
Line 8 On/Off	Start or stop line 8

Table 15: Operation monitoring file messages.

## 5. Hardware troubles records

This displays, for each material incident detected: incident ID, status (activated = ON or deactivated = OFF) as well as the date and time of occurrence or release of the event.

**Previous page**, **Next page**, and **Last page** allow access to the corresponding pages of the file: each page can display a maximum of 8 lines.

Message	Significance
DEAD	Digital module no longer responding (line cut, module failure, wrong address, module absent).
MODUL	Configuration or module address error.
TEMP+	Internal temperature of the MX 43 higher than maximum tolerated value.
TEMP-	Internal temperature of the MX 43 lower than maximum tolerated value.
BAT	Switching to external power supply.
LINE 1	Incident on line 1 (short-circuit).
LINE 2	Incident on line 2 (short-circuit).
LINE3	Incident on line 3 (short-circuit)
LINE4	Incident on line 4 (short-circuit).
LINE 5	Incident on line 5 (short-circuit).
LINE 6	Incident on line 6 (short-circuit).
LINE7	Incident on line 7 (short-circuit).
LINE 8	Incident on line 8 (short-circuit).
CAL O	Calibration defect (zero shifted).
CAL S	Calibration defect (used cell).

Message	Significance
CAL F	Calibration defect (cell oversensitive).
CAL D	Calibration defect (measurement unstable).

Table 16: Material incidents file messages.

## 6. System troubles records

This displays the events relative to MX 43 operation (power failure/fluctuation, On/Off, etc.).

**Previous page**, **Next page**, and **Last page** allow access to the corresponding pages of the file; each page can display a maximum of 8 lines.

Message	Significance
ON	MX 43 on live voltage
OFF	MX 43 off voltage
Self-testing failure	Failure of internal tests
Other messages	Contact Post-Sales Service

Table 17: System incidents file messages.

## 3. Slave info

These data enable maintenance technicians to visualize the communication framework between MX 43 and the digital modules.

## 4. Controller info

These data allow technicians to visualize MX 43 counters set to zero since the last zero setting.

## 7.4.6 6. USB Key



The *USB Key* feature is only available in *firmware* (internal software) versions 4.0 and higher.

### 1. Configuration

Define the recording parameters on the USB key and view the storage capacity remaining.

A 4G key can record approximately 18 months of information from an *MX 43* comprised of 32 detectors with a sampling frequency of 2 seconds and up to 100 events per day and per detector.

- **Data Logging:**
  - *Stop*: stop recording measurements on the USB key. Stop the USB key from recording before removing it in order to transfer the measurements recorded that day from the *MX 43* memory.
  - Begins recording measurements on the USB key at the frequency defined by the *Sampling Rate* configuration (see below). The USB key icon appears at the top of the main screen (see Figure 44) when the USB key is present and the unit has begun recording measurements.
- **Sampling Rate:** selection of the frequency of recorded measurements – *2 sec, 16 sec, 30 sec, 1 min, 2 min* or *15 min*. At any frequency setting, the *MX 43* unit saves the measurements in the internal memory every 2 seconds. For example, if the recording frequency is set at 30

seconds, the unit will record on the USB key an average value from the previous 15 measurements.

- **FIFO (First In, First Out):** defines the action to be taken when the USB key is full.
  - *Yes:* the oldest recordings (measurements and events) present on the USB key will be automatically erased.
  - *No:* when the storage capacity in use reaches 80%, the *MX 43* will display the message *Replace the key as soon as possible*. Once the USB key is almost full (98% of the storage capacity used) the alert message *USB key is full* will appear. The message *Recording impossible* will appear.
- **Fault Relay Activation:** defines the state of the default relay once the USB key is at 98%, absent when recording is activated, unformatted or in writing error mode.
  - *Yes:* the default relay is activated.
  - *No:* the default relay is not activated.
- **Bargraph / Message:** when the USB key is present, a bargraph is displayed, showing the storage capacity in use. 100% indicates that the key is full. When the key is not present but the measurement recording has been set to *Start*, the message *USB Flash is not present*, is displayed in place of the bargraph.

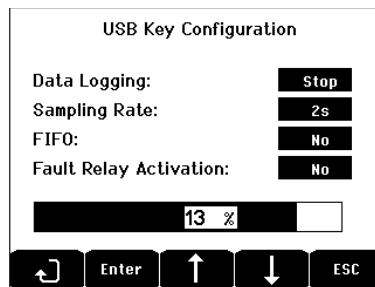

Figure 50: USB key configuration screen example.

## 2. USB files

Display the files present on the USB key, in chronological order of creation from newest to oldest. Two types of files are present:

- **Events:** files containing events saved on the USB key. Events include alarms, errors or an acknowledgment request.
- **Data:** files containing measurements saved on the USB key.

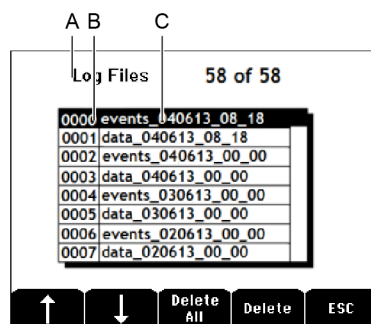

Figure 51: example of an event file and data from a USB key.

The window displays the following information:

- **Log Files xx of xx** (ref. A): the number of *Data* and *Event* files that can be opened on the *MX 43* screen over the maximum number of files currently saved on the key.
- **1<sup>st</sup> column** (ref. B): recording order number.
- **2<sup>nd</sup> column** (ref. C): name of the recording composed as follows:
  - For an event file: events\_JJMMAA\_HH\_MM.
  - For a data file: data\_JJMMAA\_HH\_MM.

*Events* and *Data* files are created automatically:

- At the beginning of the day (12:00AM);
  - Every time the *MX 43* is restarted.
- **Delete All:** erase all of the files *of the type selected* (data or events) present on the key.
  - **Delete:** erase the file selected.

NB: every time the USB key is plugged in, two hidden files are automatically created (Figure 51):

- The first file saves the complete configuration of the *MX 43* and is called config\_JJMMAA\_HH\_MM.cfg. To view or download this file, set the switch (Figure 10, ref. D) at position 2. See paragraph *Transferring configuration to the MX 43* on page 23.
- A second file saves the *MX 43 firmware* and is called firmware\_MX 43\_X\_xx.bin. To view or download this file, set the switch (Figure 10, ref. D) on position 4. See paragraph *Firmware Upload* on page 24.





# **MX 43**

ANALOG AND DIGITAL CONTROLLER  
USER GUIDE





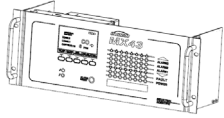
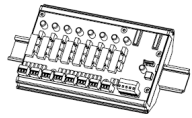
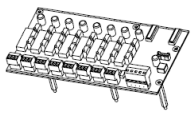
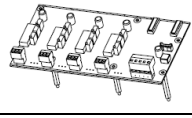
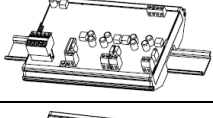
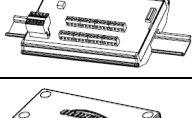
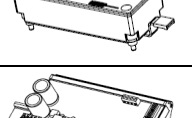
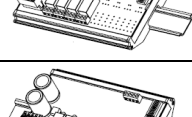
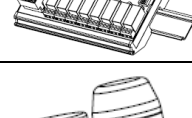

## 8 Main Part Numbers

Description	Reference	Image
MX 43 4-line controller, wall-mounted version	6 514 886	
MX 43 8-line controller, wall-mounted version	6 514 884	
MX 43 8-line controller, rack-mounted version	6 514 885	
Module with 8 analog inputs	6 314 061	
Module with 8 analog inputs for Wheatstone bridge or 4-20mA detector	6 314 063	
4-analog input PCB	6 314 085	
Module with 4 analog outputs	6 313 980	
Module with 16 logic inputs	6 313 964	
Battery pack	6 311 104	
4-relay module : 2A at 250 Vac or 30 Vdc	6 313 962	
8-relay module: 2A at 250 Vac or 30 Vdc	6 313 963	
5A at 250 Vac or 30 Vdc	6 314 219	
Red Flash and buzzer kit	6 314 066	

# MX 43

## ANALOG AND DIGITAL CONTROLLER USER GUIDE

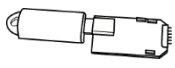
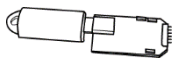
Description	Reference	Image
Blue flash and buzzer kit	6 314 152	
RS485 kit	6 314 114	
USB Acquisition module with 4G USB Key for wall-mounted <i>MX 43</i>	6 314 173	
USB Acquisition module with 4G USB Key for rack-mount <i>MX 43</i>	6 314 174	
Fuse (4 A T, 250 V AC)	6 154 715	
CR2032 lithium battery	6 111 312	
340 mA programming strip (8 maximum per analog input module), see Figure 24	6 353 442	
4-20 mA programming strip (8 maximum per analog input module), see Figure 24	6 353 443	

## 9 Cleaning and maintenance

### 9.1 Cleaning

Do not use alcohol- or ammonia-based liquids to clean the central controller. If necessary, clean the exterior of the enclosure with a damp cloth.

### 9.2 Fuse replacement

Replacement of the fuses should only be performed by a qualified professional. The fuses in use must conform to CEI 127 regulations (time-delayed, low breaking capacity, 250 V AC power source). Please see chapter 8 and 14 for cabinet versions.

# **MX 43**

ANALOG AND DIGITAL CONTROLLER  
USER GUIDE



## 10 Certificate of Compliance

The document hereafter (2 pages) reproduces the EU declaration of conformity.

**DECLARATION UE DE  
CONFORMITÉ****EU CONFORMITY  
DECLARATION**

Réf : UE\_MX43\_rev C.2.doc

Nous,  
We,**Teledyne Oldham Simtronics S.A.S.**, ZI Est, 62000 Arras FranceDéclarons, sous notre seule responsabilité, que le matériel suivant :  
*Declare, under our sole responsibility that the following equipment :***centrale de mesure MX43 (MX43 Controller)****reliée aux détecteurs de gaz (connected to gas detectors):  
CEX300, TBGW-Ex, OLC(T) IR, 20, 40, 50, 60, 100**Est conçu et fabriqué en conformité avec les Directives et normes applicables suivantes :  
*Is designed and manufactured in compliance with the following applicable Directives and standards:***D) Directive Européenne ATEX 2014/34/UE du 26/02/14: Atmosphères Explosives***The European Directive ATEX 2014/34/EU dated from 26/02/14: Explosive Atmospheres*Normes harmonisées appliquées:  
*Harmonised applied Standards***EN 60079-29-1 : 2016  
EN 50271 : 2010**

Catégorie (Category):

**II (1) G D**

Attestation CE de Type du matériel:

**INERIS 13ATEX0048***EC type examination certificate*Notification Assurance Qualité de Production:  
*Notification of the Production QA***INERIS 00ATEXQ403**Délivrés par l'Organisme notifié numéro 0080:  
*Issued by the Notified Body n°0080***INERIS, Parc Alata  
60550 Verneuil en Halatte France**

Page 1 | 2

**DECLARATION UE DE  
CONFORMITÉ****EU CONFORMITY  
DECLARATION**

Réf : UE\_MX43\_rev C.2.doc

**II) Directive Européenne CEM 2014/30/UE du 26/02/14: Compatibilité Electromagnétique**  
*The European Directive EMC 2014/30/UE dated from 26/02/14: Electromagnetic Compatibility*Normes harmonisées appliquées :  
*Harmonised applied Standards***EN 50270: 2015 for type 2****III) Directive Européenne DBT 2014/35/UE du 26/02/14: Basse Tension**  
*The European Directive LVD 2014/35/UE dated from 26/02/14: Low Voltage*Normes harmonisées appliquées:  
*Harmonised applied Standard***EN 61010-1 : 2010****IV) Sécurité Fonctionnelle (Functional Safety)**Niveau d'intégrité de Sécurité  
*Safety Integrity Level***SIL 1**

Ce matériel ne doit être utilisé qu'à ce pour quoi il a été conçu et doit être installé en conformité avec les règles applicables et suivant les recommandations du fabricant.  
*This equipment shall be used for the purpose for which it has been designed and be installed in accordance with relevant standards and with manufacturer's recommendations.*

A Arras, le 09/07/2020 / Arras, July 9<sup>th</sup>, 2020AM. Dassonville  
Certification Responsible

**Teledyne Oldham Simtronics S.A.S.**  
Z.I. EST - C.S. 20417  
62027 ARRAS Cedex – FRANCE  
Tel. : +33(0)3 21 60 80 80  
www.teledyneGFD.com

*Dass*

Page 2 | 2

# **MX 43**

ANALOG AND DIGITAL CONTROLLER  
USER GUIDE

The document below (1 page) reproduces the Marine Directive declaration of conformity.



 <b>TELEDYNE OLDHAM SIMTRONICS</b> Everywhereyoulook™	<b>UE DECLARATION OF CONFORMITY TO TYPE FOR MX43</b>
	In accordance with the Marine Equipment Directive (MED) 2014/90/UE, as amended Order Number: .....

**Manufacturer's, or his authorized Representative's name & address:**  
TELEDYNE OLDHAM SIMTRONICS- ZI EST – CS 20417- 62027 ARRAS CEDEX

In compliance with Article 16 of the Council Directive 2014/90/UE, the Marine Equipment Directive, as amended. We declare under our sole responsibility that the products detailed below conform to type, as described in the EC Type Examination certificate:

No 58272/B0 MED, issued by Bureau Veritas on 17 Sept 2020

**Product Types:** MX 43 in wall mount format

**Product Descriptions:** MX 43, Gas Detection Control Panel

**Serial Numbers (S/N) of products:** .....

We further declare also that these products have been marked for their identification in accordance with Article 9 of the Marine Equipment Directive, after having been duly authorized by the EC Notified Body, the identification number of whom is stated below.

**Modules for Production conformity assessment, within which the EC Declaration of conformity is issued:**  
Module D - Production-Quality Assurance,  
Quality System Approval Certificate N° SMS.MED2.D\_127472\_A.1, issued by Bureau Veritas (NB 2690) on Nov. 12th, 2020

**Limitation/Application:**  
The equipment fulfils the EMC requirements for installation in General Power Distribution Zone and / or Deck Zone.  
The equipment can not to be mounted in consoles, housings.  
The following component(s) shall comply with the requirements of MED2014/90/EU, as amended, and be wheelmarked:  
MX43

**REGULATIONS and STANDARDS complied with:**  
SOLAS 74 convention as amended, Regulations II-2/4, VI/3.  
IMO Res. MSC.98(73) -(FSS Code)- as amended by MSC.206(81), MSC.217(82), MSC.292(87), MSC.311(88), MSC.327(90), MSC.339(91) and MSC.457(101), 15  
IMO MSC.1/Circ.1370  
IEC 60092-504:2016  
IEC 60533:2015  
EN 50104:2010 and EN 60079-29-1:2016  
EN 60079-0:2012 ind. /A11:2013

**MARKING & IDENTIFICATION AFFIXED TO THE PRODUCTS:**

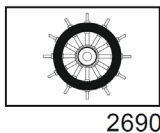

<b>Prod. Year :</b> YYYY <b>Serial Number :</b> YY-XXXXX (The first 2 digits indicate the year of manufacture)
--

Issued at ARRAS FRANCE, on .....

Marc Triquet  
Quality Manager

MX43\_MED DoC\_F2013-01\_G.docx

# **MX 43**

ANALOG AND DIGITAL CONTROLLER  
USER GUIDE



# 11 Technical Specifications

## 11.1 MX 43 Controller

### Function

Function: Gas Detection Controller.

Number of lines: 4 or 8 as per model.

### Display and indicators

Display: Back-lit graphic LCD

Status indicators:

- 7 LEDs for each of the 8 lines, or 56 LEDs.
- 1 live voltage indicator for the controller.
- 1 general failure indicator.

### Keys

Selection: 5 multifunction soft-touch keys.

Alarm release: Dedicated soft-touch key.

### Alarms

Limits: Parameter setting by COM 43 application.

Indicators: 6 status LEDs per line (high- and low-range excess, Alarm 3, Alarm 2, Alarm 1, failure).

Internal relay:

- 5 fully programmable relays (configuration over COM 43).
- 1 failure relay (non-modifiable).
- RCT contact on each relay. Nominal load of contacts: 2A–250 V AC or 30 V DC, resistive load.
- Output at screwed terminals Maximum admissible cable diameter 2.5 mm<sup>2</sup>.

**Measurement Lines**

Digital lines:

- 8 maximum.
- RS485 Modbus, 9600 Bauds.
- Industrial computer cable, 2 shielded twisted pairs (1 for the line and 1 for communication), adapted to 100 Ohms.

Analog lines:

- 8 maximum.
- Input range 4 to 20 mA.
- Load resistance 120 Ohms.
- Analog transmitter cable 2 or 3 shielded wires.

Nominal voltage: 21 to 28 V on external DC.

Maximum current available per line:

- 1.2 A (peak 1.5 A) with Rev. C mother board starting from 01 August 2013.
- 500 mA with Rev. A and Rev. B mother boards.

Total maximum current for lines: 3.2 A CC or 4 A per peak.

Total power available as per temperature:

Room T° ≤ 20°C = 68 W.  
 Room T° 20 to 30°C = 55 W.  
 Room T° 30 to 40°C = 41 W.  
 Room T° 40 to 50°C = 27 W.

Cables outputs: (only for wall-mounted version)

- 12 PE M16 for cables of 4 to 8 mm<sup>2</sup>.
- 6 PE M20 for cables of 6 to 12 mm<sup>2</sup>.

Insulation: 1500 V AC (power–digital network).

Output: On screwed terminals. Maximum admissible conductor section 2.5 mm<sup>2</sup>.

**Electrical characteristics**

AC power supply:

- 100 to 240 V AC, 50/60 Hz.
- Maximum input current 1.5 A.
- Maximum consumption: 230 VA.

DC power supply:

- 21 to 28 V DC.
- Maximum input current 4 A.
- Maximum consumption: 135 VA.

**Mechanical characteristics**

Installation:

- Wall-mounted version: on special screwed support.
- Rack-mounted version: Cut-out of 177 x 437 mm.

**Mechanical characteristics**

Dimensions:	<ul style="list-style-type: none"> <li>• Wall-mounted version: 370 x 299 x 109 mm.</li> <li>• Rack-mounted version: 482.8 x 177 x 192.5 mm (19", 4 U).</li> </ul> <p>See Figure 4 and Figure 6.</p>
Weight:	<ul style="list-style-type: none"> <li>• Wall-mounted version: 4.0 kg.</li> <li>• Rack-mounted version: 2.0 kg.</li> </ul>
Protection level:	<ul style="list-style-type: none"> <li>• Wall-mounted version: IP55.</li> <li>• Rack-mounted version: IP 31.</li> </ul>
Locking:	<ul style="list-style-type: none"> <li>• Wall-mounted version: by 2 locks with a key.</li> <li>• Rack-mounted version: none.</li> </ul>

**Environmental characteristics****Conditions of use**

Temperature of use:	-20 to +50°C. (as per power used; cf. preceding page).
Storage temperature:	-20 to +50°C.
Humidity:	5 to 95% relative humidity non condensed.
Pressure limits	Atmospheric +/-10%
Storage pressure	Atmospheric +/-20%
Storage duration	1 year (Lithium battery)

**Standards**

Electromagnetic compatibility:	as per EN50270, industrial type 2.
ATEX:	as per 60079-29-1 and EN50271.
Low voltage directive:	as per EN61010.
CSA:	as per C22.2 no.152 (pending).

## 11.2 Relay Module

**Function**

Function	Management of 4 or 8 relays from the digital signals issued by the MX 43.
Number of relays:	<ul style="list-style-type: none"> <li>• 4 or 8 relays.</li> <li>• CRT outputs</li> </ul>
Relay type:	<ul style="list-style-type: none"> <li>• Bistable.</li> <li>• Energized or de-energized configuration by mini-switches.</li> <li>• Setting of relay parameters by COM 43 application.</li> </ul>

Function	
Nominal load of contacts:	250 V AC – 2 A or 30 V DC – 2A, resistive load (6 313 963) 250 V AC – 2 A or 30 V DC – 5A, resistive load (6 314 219)
Consumption:	3.5 mA in normal operation.
Connections:	<ul style="list-style-type: none"> <li>• Screwed terminals.</li> <li>• Connector detachable without cutting the line.</li> <li>• Tightening torque: 0.5-0.6 Nm.</li> <li>• Cable: 2.5 mm<sup>2</sup> maximum.</li> </ul>
Logic inputs:	2 additional logic inputs (dry contacts).
Assembly:	Snap-on on DIN rail.
Dimensions:	125 x 165 x 60 mm.

### 11.3 16-Logic Input Module

Function	
Function	Logic input monitoring.
Capacity:	1 to 16 logic inputs (dry contacts).
Connections:	<ul style="list-style-type: none"> <li>• Screwed terminals.</li> <li>• Connector detachable without cutting the line</li> <li>• Tightening torque: 0.5-0.6 Nm.</li> <li>• Cable: 2.5 mm<sup>2</sup> maximum.</li> </ul>
Consumption:	2 mA in normal operation.
Assembly:	Snap-on on DIN rail.
Dimensions:	125 x 165 x 60 mm.

### 11.4 8-Analog Input Module

Function	
Function:	4-20mA detector or Wheatstone bridge connections.
Capacity:	1 to 8 independent inputs.
Connections:	<ul style="list-style-type: none"> <li>• Screwed terminals.</li> <li>• Connector detachable without cutting the line.</li> <li>• Tightening torque: 0.5-0.6 Nm.</li> <li>• Cable: 2.5 mm<sup>2</sup> maximum.</li> </ul>
Consumption:	53 mA max (detector excluded).

**Function**

Operating temperature:	<i>8 bridges</i> -30°C (8 bridges up to 1 km). -40°C (8 bridges up to 500 m). <i>4 bridges</i> -45°C (4 bridges up to 1 km). -50°C (4 bridges up to 500 m).
------------------------	--

Assembly:	Snap-on on DIN rail or mounted on the inside of MX 43.
-----------	--

Dimensions:	125 x 165 x 60 mm.
-------------	--------------------

## 11.5 4-Analog Output Module

**Function**

Function:	Generation of 1 to 4 analog values.
-----------	-------------------------------------

Capacity:	<ul style="list-style-type: none"> <li>• 4 independent opto-isolated outputs 4-20mA (recopy detector, minimum, maximum, or average of a detector group).</li> <li>• Resistance of maximum load 500 Ω.</li> </ul>
-----------	--

Logic inputs:	2 additional logic inputs (dry contacts).
---------------	---

Connections:	<ul style="list-style-type: none"> <li>• Screwed terminals.</li> <li>• Connector detachable without cutting the line</li> <li>• Tightening torque: 0.5-0.6 Nm.</li> <li>• Cable: 2.5 mm<sup>2</sup> maximum.</li> </ul>
--------------	---

Consumption:	<ul style="list-style-type: none"> <li>• &lt; 5 mA with the 4 lines at stop.</li> <li>• &lt; 36 mA for an activated line.</li> <li>• &lt; 130 mA for the 4 activated lines.</li> </ul>
--------------	--

Assembly:	Snap-on on DIN rail.
-----------	----------------------

Dimensions:	125 x 165 x 60 mm.
-------------	--------------------

# **MX 43**

ANALOG AND DIGITAL CONTROLLER  
USER GUIDE





## 12 RS485 Digital Output

The *MX 43* units using the *RS485 Modbus* option are equipped with a communication card (code 6314114), which is affixed to the motherboard. This card generates a RS485 output in *Modbus RTU* format.

### 12.1 Card description

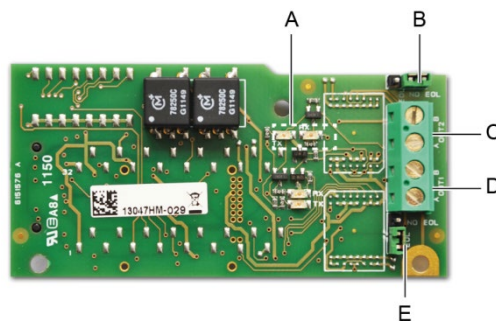

Figure 52: the RS485 card.

Rep.	Function
A.	Operating LEDs. The <i>Rx</i> LED lights up when a data thread is received. The <i>Tx</i> LED indicates that the card has power and turns off when data is being transmitted out.
B.	Unused switch.
C.	Unused output.
D.	Connection terminal for output n° 1. A = Tx or +RS485. B = Rx or -RS485.
E.	End Of Line ( <i>EOL</i> ) resistance for output No. 1. Set the switch to the <i>EOL</i> position for the unit that is the last module in the RS485 network. For other units, set the switch to NO EOL.

The RS485 output can be configured using the *COM 43* software, or using unit menu *2.4 Program >RS485 Port* (see page 48).

## 12.2 Transfer Table

Two types of information can be retrieved *via* the RS485 output:

- Information about sensor configuration;
- Real-time sensor information (measurements, alarms, etc.).

### 12.2.1 Access to configuration information

It is possible to access the installation configuration (for example, to access the alarm thresholds or the names of the sensors).

This configuration information is listed in the transfer table from address 0 to address 1999.

The address of the detectors is determined as follows:

- For a digital sensor:  
Sensor address = (line number – 1) x 32 + slave number
- For an analog sensor:  
Sensor address = 256 + line number

Once the sensor address is known, the desired request can be executed by following the transfer table below. For example, to find the instantaneous alarm threshold number 1 for a sensor, read register number 52.

All of the information at addresses 1 to 52 will be accessed. The 52<sup>nd</sup> word corresponds to the expected value.

#### *Example*

Access instantaneous alarm 1 for the sensor located on line 8 at address 2 of unit 2.

A. Determination of the sensor address:  $(8 - 1) \times 32 + 2 = 226$ .

B. Structure of the *Modbus* request:

- Slave number for the unit (defined by COM 43)      02 = 0x02
- Operating type (03 = read)                              03 = 0x03
- Sensor address    226 = 0x00E2
- Number of words to read (see Excel document)      52 = 0x3A
- CRC

Thread: 0x02 0x03 0x00 0xE2 0x00 0x3A 0x65 0xDC

### 12.2.2 Access to real-time information

Measurement and alarm information from the detectors is listed in the transfer table from address 2000 to 65535. The sensor measurements are available at addresses 2001 to 2264, the sensor statuses are available at addresses 2301 to 2564 (alarm 1, alarm 2, etc.).

**Example**

Access to measurements from the sensor located at line 3 and address 32 of unit n° 2.

A. Determination of the sensor address:  $(3 - 1) \times 32 + 32 = 96$ .

B. Structure of the *Modbus* request:

- Slave number for the unit (defined by COM 43)    02 = 0x02
- Operating type (03 = read)    03 = 0x03
- Address of the 1st word    2000+96 = 0x0830
- Number of words to read    01 = 0x0001
- CRC

Thread: 0x02 0x03 0x08 0x30 0x00 0x01 0x86 0x56

**Example**

Access the status of the sensor located at analog input 5 of unit n° 2.

A. Calculation of the table index:  $256 + 5 = 261$

B. Request script:

- Slave number for the unit (defined by COM 43)    02 = 0x02
- Operating type (03 = read)    03 = 0x03
- Address of the 1st word    2300 + 261 = 0x0A01
- Number of words to read    01 = 0x0001
- CRC

Thread: 0x01 0x03 0x0A 0x01 0x00 0x01 0xD6 0x21

## 12.3 Address Table

### 12.3.1 Supervision of the MX 43 sensors

All reading requests for the *Modbus* are done *via* function 3. The cartography is shown below:

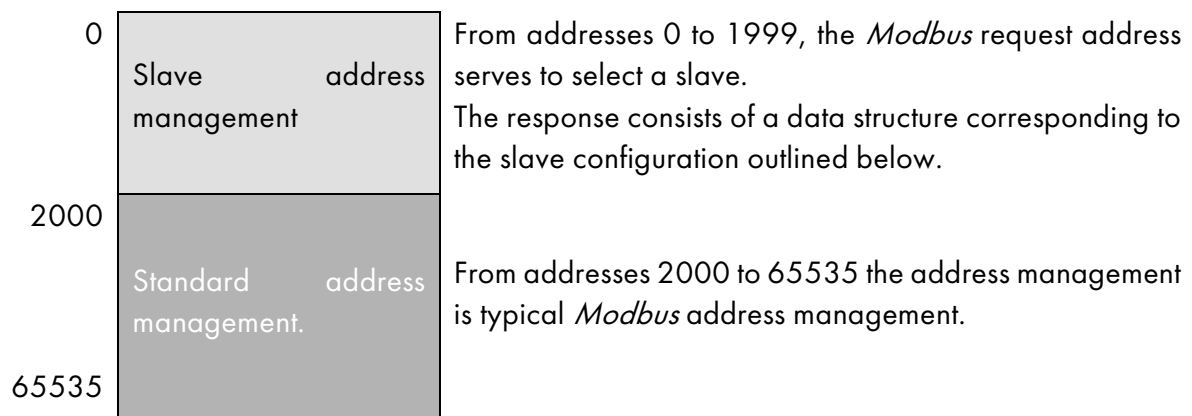

## 12.3.2 Configuring sensors

### Downloading the configuration

The *MX 43* uses 256 external addresses (line #1 channel #1, to line #8 channel #32) and 8 analog channels for which the addresses are located from 257 to 264.

With the automated system, it is possible to send 264 (256 + 8) *Modbus* requests, where the address field is numbered from 1 to 264 in order to download the configuration of each sensor into the internal memory.

As a result of the operating functionality, it is only possible to repatriate the data of a single sensor for interrogation.

If a sensor is stated at the address mentioned, the *MX 43* sends the number of data words requested; always from data #1: NAME OF ANALOG SENSOR, at data #x.

If there is no information at the address mentioned, the *MX 43* sends back 0.

1	Line 1	Sensor 1
32	Line 1	Sensor 32
33	Line 2	Sensor 1
64	Line 2	Sensor 32
65	Line 3	Sensor 1
96	Line 3	Sensor 32
97	Line 4	Sensor 1
128	Line 4	Sensor 32
129	Line 5	Sensor 1
160	Line 5	Sensor 32
161	Line 6	Sensor 1
192	Line 6	Sensor 32
193	Line 7	Sensor 1
224	Line 7	Sensor 32
225	Line 8	Sensor 1
256	Line 8	Sensor 32
257	Analog line unit number 1	
264	Analog line unit number 8	

**Sensor addresses**

Address	SENSORS [256 + 8]	Nb bytes	Data type												
1	Com sensor	2 X 16	Unicode text (16 bits) 16 characters including the final /0.												
17	Status	2	Start / Stop: if in operation, variable = 1. If stopped, variable = 0.												
18	Gas name	2 x 20	Unicode text (16 bits) 20 characters including the final /0.												
38	Range	2	Value The range is from 1 to 5000.  Range X 10 display format.  The display format is given in another box.												
39	Display format	2	Coded value.												
40	Unit	2 X 5	Unicode text (16 bits) 5 characters including the final /0.												
45	Abbreviated gas name	2 x 6	Unicode text (16 bits) 6 characters including the final /0.  CAUTION, if the first 2 letters = O2: special treatment.												
51	Zone	2	Value	1 to 8											
52	Instantaneo us alarm threshold 1	2	Value	-999 to 9999 (real value to be multiplied like the range)											
53	Instantaneo us alarm threshold 2	2	Value	-999 to 9999 (real value to be multiplied like the range)											
54	Instantaneo us alarm threshold 3	2	Value	-999 to 9999 (real value to be multiplied like the range)											
55	Average alarm threshold 1	2	Value	-999 to 9999 (real value to be multiplied like the range)											
56	Average alarm threshold 2	2	Value	-999 to 9999 (real value to be multiplied like the range)											
57	Average alarm threshold 3	2	Value	-999 to 9999 (real value to be multiplied like the range)											
58	Underscale threshold	2	Value	-999 to 9999 (real value to be multiplied like the range)											

Address	SENSORS [256 + 8]	Nb bytes	Data type									
59	Overscale threshold	2	Value	-999 to 9999 (real value to be multiplied like the range)								
60	Default low threshold	2	Value	-999 to 9999 (real value to be multiplied like the range)								
61	Out of range threshold	2	Value	-999 to 9999 (real value to be multiplied like the range)								
62	Integration time alarm 1	2	Value	15 - 480 min per 1 min step (if not used, put 15 min)								
63	Integration time alarm 2	2	Value..	15 - 480 min per 1 min step (if not used, put 15 min)								
64	Integration time alarm 3	2	Value	15 - 480 min per 1 min step (if not used, put 15 min)								
65	Hysteresis	2	Value	Caution, max = 5% of the range. Always use a positive value and not a percentage.								
66	Alarm active?	2	Configuration per bit	Al active inst, avg: 1, 2, 3.		bit 6	bit 5	bit 4	bit 3	bit 2	bit 1	bit 0
				0 = inactive 1 = active			Alarm	Alarm	Alarm	Alarm	Alarm	Alarm
67	Acknowl alarm? (Auto/manu ) Verification	2	Configuration per bit	Manual acknowl Al 1, 2, 3, verification	bit 7	bit 6	bit 5	bit 4	bit 3	bit 2	bit 1	bit 0
				1 = Manual acknowl and 0 = Automatic Acknowl. When the <i>Verification</i> is at 1, the <i>Verification</i> alarm, once activated, is deactivated by stopping the sensor. If the acknowledgment is manual, alarms 1, 2 or 3, once activated, are deactivated using the acknowl button + measurement < alarm.	1 = verification	put 0 mandatory	put 0 mandatory	put 1 mandatory	put 0 mandatory	1=A13 ackmanu	1=A12 ackmanu	1=A11 ackmanu

Address	SENSORS [256 + 8]	Nb bytes	Data type									
68	Increasing or decreasing alarm?	2	Configuration per bit	Al 1, 2, 3 instantaneous or average increasing or decreasing								
				1: increasing 0: decreasing			Alarm avg 3	Alarm avg 2	Alarm avg 1	Alarm inst 3	Alarm inst 2	Alarm inst 1

Table of registers

### 12.3.3 Acquisitions retrieved cyclically

Real address	SENSOR MEASUREMENTS [256 + 8]	Nb bytes	Data type
Start: 2001 end : 2264	Sensor measurement	2	Table with 264 total 16 bit symbols where the measurements are listed at their address. The measurement being whole, the automatic system uses the <i>Display format</i> field to determine where to position the comma.

Real address	ALARMS [256 + 8]	Nb bytes	Data type
Start: 2301 end : 2564	Table of activated alarms	2	Table with 264 total 16 bit non symbols where the alarms bits are listed at their address. ALARM_1 (bit 0) ALARM_2 (bit 1) ALARM_3 (bit 2) UNDERSCALE (bit 3) OVERSCALE (bit 4) AL_DEFAULT (bit 5) AL_OUT_OF_RANGE (bit 6) L_VERIFICATION (bit 7) Bits 8 to 16 not in use

Real address	INFO	Nb bytes	Data type
2600	CRC32 of the general configuration	2	32 most significant bits option. Note: CRC32 of the entire configuration except the relays (from 0x78000 to 0x7AFFC). If different, re-upload the configuration.
2601		2	32 least significant bits option.
2602	Second counter	2	32 most significant bits option; Note: this counter increases every second and verifies that the unit is active.
2603		2	32 least significant bits option.

# **MX 43**

ANALOG AND DIGITAL CONTROLLER  
USER GUIDE





## 13 Functional Safety



The reliability data below only concerns MX43 controllers in wallmount and rack versions and does not include modules.

### 13.1 Reliability data

The MX43 controller is certified according to the European standard EN 50271 “Electrical apparatus for the detection and measurement of combustible gases, toxic gases or oxygen. Requirements and tests for apparatus using software and/or digital technologies”.

Concerning the requirements relative to the software development process, standard EN 50271 specifies a practical approach in order to satisfy the requirements of EN 61508-3 for the safety integrity level SIL 1.

The French Notified Body INERIS certified that the MX 43 controller conforms to the necessary requirements and level SIL 1.

Configuration	MTBF (years)	SFF	PFDavg	SIL maximum
4 lines 24 VDC	19.95	60%	$1.03 \cdot 10^{-2}$	1
8 lines 24 VDC	17.39	60%	$1.18 \cdot 10^{-2}$	1
4 lines 230 VAC	14.34	60%	$1.43 \cdot 10^{-2}$	1
8 lines 230 VAC	12.97	60%	$1.58 \cdot 10^{-2}$	1

Ti: 12 months

Mean Time to Repair (MTTR): 48 hours

Recommended operating life: 20 years

For gas detection control unit or separate gas detection control unit, the **maximum delay time until special state is entered in case of transmission errors** is 8 seconds.

The time of response of the entire system is determined by the time of response of all parts of equipment within the gas detection system

## 13.2 Specific Conditions of Use

The safety function of the MX 43 is the processing of the signal of the detectors linked to its input. As soon as a measurement reaches a programmed threshold, an audio and visual alarm goes off. Simultaneously, the possible corresponding alarm relay(s) is (are) activated, commanding additional internal or external actions set forth by the user.

In case of system failure, the internal fault relay opens to indicate a fault status (see Figure 34: Internal alarm relay connectors (A)).

The fault relay switch moves upon one of the following events:

- Internal error MX 43
- Loss of power MX 43
- Detector fault
- Connection fault between a measuring line and a detector

The safety function is not assured at the powering up of the controller and during the time of programmable stabilization from 30 to 500 seconds.

It is imperative to connect the fault relay and to process this information in any installation where an SIL level is required.

Once per year minimum, it is suggested to voluntarily trigger a fault on one of the measuring lines, by disconnecting a detector, for example, and checking the proper switching of the fault relay.

## 13.3 Specific Conditions of Use for FM

The MX43-M Gas Detection Control Panel complies with the relevant gas detection performance standard listed on the label when connected to a Detector that also has been evaluated to the same gas detection performance standard.

All unused device openings must be closed.

For field connections use wire rated 20°C greater than maximum ambient temperature.

## 13.4 Connecting detectors other than TELEDYNE OLDHAM SIMTRONICS detectors to the MX 43 controller

Any user wishing to use detectors other than *TELEDYNE OLDHAM SIMTRONICS* detectors must ensure that they are compatible with the controller, in order for the unit to be considered a safety device.

### 13.4.1 Transfer table

The following table demonstrates the controller status in terms of values measured and treatment of faults, as a function of the value of the input current delivered by the detector. In the case that

the user connects a non- *TELEDYNE OLDHAM SIMTRONICS* brand detector to the *MX 43* controller, the user must ensure that the detector is compatible with the input characteristics for the controller, so that the information delivered by the detector will be properly interpreted. In addition, the controller must provide sufficient supply voltage, taking into account voltage drops in the cables.

Detector signal output	MX 43 status
0 to 2.4 mA	Fault
>2.4 to 21.6 mA	Measurement
>21.6 mA	Over Range Fault

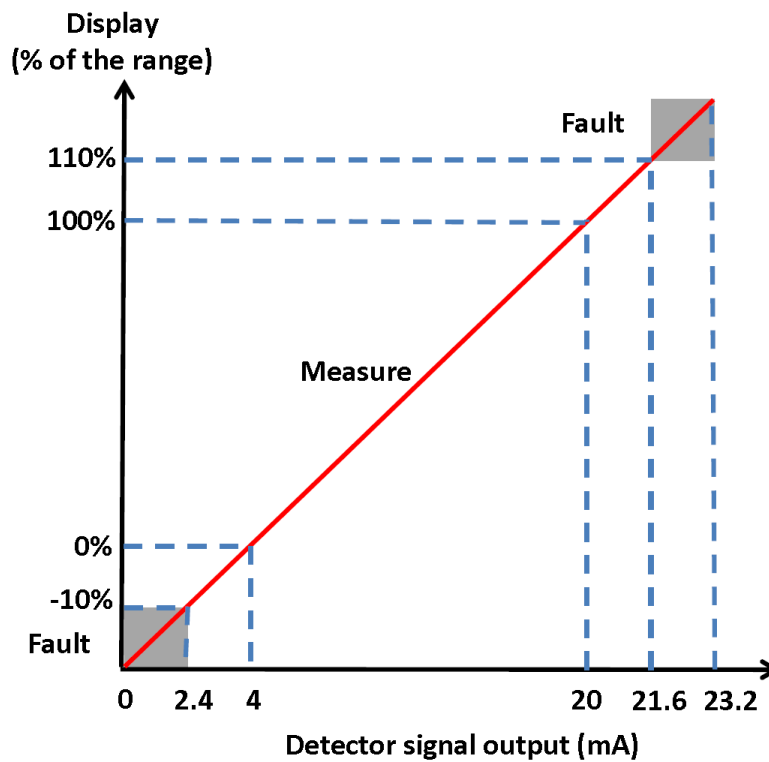

# **MX 43**

ANALOG AND DIGITAL CONTROLLER  
USER GUIDE



# 14 MX 43 in cabinets

## 14.1 Presentation

The *MX 43* control panels are available in 3 versions and 2 material types (Polyester or Painted steel or Stainless Steel).

- Model **MX43-EB** (Extra Box). It includes a maximum of 2 modules from the 8 relay modules (ROM), 8 analog input modules (AIM) and the supply. These modules are able to be remote from the Master Control Panel.



Control panel material	Dimensions (HxLxD in mm)
Polyester	360x305x212
Painted Steel	430x300x120
Stainless Steel	430x300x120

- Model **MX43-S** (Small). It includes the MX43 Control panel as well as 2 modules from the 8 relay modules (ROM), 8 analog inputs (AIM), 4 analog outputs 4-20mA (AOM) or 16 logic inputs (LIM).



Control panel material	Dimensions (HxLxD in mm)
Polyester	600x400x230
Painted Steel	500x500x200
Stainless Steel	500x500x200

- Model **MX43-L** (Large). It includes the MX43 Control panel as well as 6 modules from the 8 relay modules (ROM), 8 analog inputs (AIM), 4 analog outputs 4-20mA (AOM) and 16 logic inputs (LIM).



Control panel material	Dimensions (HxLxD in mm)
Polyester	625x612x329
Painted Steel	600x600x300
Stainless Steel	600x600x300

## 14.2 Codification

### 14.2.1 MX43-EB

MX43-EB	A	B	C	D	E	F	G
<b>Approvals</b>							
A	CE						
B	CE + CSA Hazardous Location						
<b>Enclosure</b>							
FI	Glass-fiber Reinforced Polyester – available for CE + CSA						
PS	Painted steel – only for CE approval						
ST	Stainless steel – available for CE + CSA						
<b>AC/DC Power supply<sup>(1)</sup></b>							
0	Without						
1	With						
<b>Qty of AIM<sup>(1)</sup></b>							
0							
1							
2							
<b>Qty of ROM<sup>(1)</sup></b>							
0							
1							
2							
<b>Qty of AOM<sup>(1)</sup></b>							
0							
1							
2							
<b>Qty of LIM<sup>(1)</sup></b>							
0							
1							
2							

<sup>(1)</sup> Maximum of 2 modules among 8-relay modules (ROM), 8-Analog input modules (AIM), 4-analog output modules (AOM), 16-logic modules (LIM) and power supply module.

**Example:** MX43-A-CE-FI-1-0-1-0-0

Control panel MX43-EB in polyester fiber CE certified, including 1 module 8 relays (ROM) and a 110Vac supply.

## 14.2.2 MX43-S

MX43-S	A	B	C	D	E	F	G	H	I
<b>Approvals</b>									
A									
CE									
B									
CE + CSA Hazardous Location									
<b>Enclosure</b>									
FI									
Glass-fiber Reinforced Polyester – available for CE + CSA									
PS									
Painted steel – only for CE approval									
ST									
Stainless steel – available for CE + CSA									
<b>Alarm</b>									
0									
Without									
A									
Red with buzzer									
B									
Blue with buzzer									
C									
Amber with buzzer									
<b>Option</b>									
0									
None									
1									
with COM43									
2									
with USB datalogging									
3									
with COM43 & USB datalogging									
<b>Communication</b>									
0									
None									
1									
with RS485 Modbus communication card									
2									
with Communication module RS485 and TCP/IP Modbus									
<b>Qty of AIM<sup>(1)</sup></b>									
0									
1									
2									
<b>Qty of ROM<sup>(1)</sup></b>									
0									
1									
2									
<b>Qty of AOM<sup>(1)</sup></b>									
0									
1									
2									
<b>Qty of LIM<sup>(1)</sup></b>									
0									
1									
2									

<sup>(1)</sup> Maximum of 2 modules among 8-relay modules (ROM), 8-Analog input modules (AIM), 4-analog output modules (AOM), 16-logic modules (LIM).

**Example:** MX43-S-A-FI-E-0-0-1-1-0-0

Panel MX43-S in polyester fiber, CE certified, including a blue light and a buzzer, 1 analog input module (AIM), and 1 relay module (ROM)

### 14.2.3 MX43-L

MX43-L	A	B	C	D	E	F	G	H	I
<b>Approvals</b>									
A		CE							
B		CE + CSA Hazardous Location							
<b>Enclosure</b>									
FI		Glass-fiber Reinforced Polyester – available for CE + CSA							
PS		Painted steel – only for CE approval							
ST		Stainless steel – available for CE + CSA							
<b>Alarm</b>									
0		Without							
A		Red with buzzer							
B		Blue with buzzer							
C		Amber with buzzer							
<b>Option</b>									
0		None							
1		with COM43							
2		with USB datalogging							
3		with COM43 & USB datalogging							
<b>Communication</b>									
0		None							
1		with RS485 Modbus communication card							
2		with Communication module RS485 and TCP/IP Modbus							
<b>Qty of AIM<sup>(1)</sup></b>									
3									
4									
<b>Qty of ROM<sup>(1)</sup></b>									
0									
1									
2									
<b>Qty of AOM<sup>(1)</sup></b>									
0									
1									
2									
<b>Qty of LIM<sup>(1)</sup></b>									
0									
1									
2									

<sup>(1)</sup> Maximum of 3 additional modules among 8 relay modules (ROM), 8 analog inputs (AIM), 4 analog outputs (AOM) and 16 logic inputs (LIM).

Example: MX43-L-A-ST-A-2-1-3-1-1-1

Panel MX43-L in stainless steel, CE certified, including a red lamp and a buzzer, 3 analog input modules (AIM), 1 relay module (ROM), 1 analog output module (AOM) and 1 logic input module (LIM), with registration of data on USB key and TCP/IP interface.



## 14.3 Electrical connections

The electrical connections must be carried out by qualified personnel with respect to the different regulations in force in the installation country.



No modifications to the control panel are authorised without prior agreement from TELEDYNE OLDHAM SIMTRONICS SAS. Modification of the equipment and use of parts not stipulated to be original spare parts will lead to cancellation of any form of guarantee and may call into question product certifications.

Please refer to the wiring diagram supplied with the equipment.

For the MX43-L model, the mother-board connections are to be made on remote terminals inside the panel. Connections must not be made directly to the mother-board.



Certain voltages may lead to serious injury, even mortal. Please install the equipment and complete the wiring before putting under power.

Poor installation may lead to measurement errors or system failure, it is essential to carefully follow all instructions in this manual in order to guarantee the correct operation of the system.

The temperature inside the control panel may reach 70°C (158 °F), it is essential to use cables the service temperature of which exceeds 70°C (158 °F).

### 14.3.1 Model MX43-EB

The architecture depends on the panel material. See Figure 53, Figure 54 or Figure 55.



It is possible to select the AC supply voltage for the stainless steel panels MX43-EB (option). This operation is factory set according to the desired configuration. Before connecting, or in case of supply replacement, ensure that the selector is in the correct position (115Vac or 230Vac, marked H, Figure 54)

	Terminal marks	Terminal
AC or DC supply	N / 0Vdc	1
	L / +24Vdc	2
		3
Digital communication RS485	A	1
	B	2
	screening	3

For the digital RS485 communication, use a screened cable, 1 twisted pair, section 0.22 m<sup>2</sup> minimum type MPI-22A, with nominal impedance 100 Ohms (see chapter 5) without forgetting to connect the screening to terminal 3 of the XL.

For the 8 relay modules (ROM) connections, refer to chapter 6.

For connection of the detectors to the 8 analog input modules (AIM), please refer to 6.

The detector cable screens should be connected to the cable screen terminal for all the digital and analog links (marked G, Figure 53, Figure 54 or Figure 55).

### 14.3.2 Model MX43-S

Implantation depends on the panel material. See Figure 56 or Figure 57



To gain access to the mothercard terminals, remove the protective cover (marked ZZ).

It is essential to replace this protective cover once the connections have been made

		Terminal marks	terminal
AC supply	N	1	XA
	L	2	
	⊕	3	
Relay contact <i>Default setting</i>	NO	1	XF
	C	2	
	NC	3	
Relay contact <i>Alarms 1 to 5</i>	NO	See mark H, Figure 54	
	C		
	NC		

Lines 2 to 8 on the motherboard are available for connecting additional modules or analog/digital detectors. Any changes to the configuration require reprogramming of the master control panel via the COM 43 application.

The external flashing lamp and the external siren (option) are connected to terminals J6 and J8 found on the motherboard (factory fitted if configured on ordering).

For the connections concerning the 8 relay modules (ROM) and the 8 analog inputs modules (AIM), please refer to chapter 6.

The detector cable screens should be connected to the common terminal strip for the digital and analog cable screening (G in Figure 56 or Figure 57).

### 14.3.3 Model MX43-L

See Figure 58.

		Terminal No.	Terminal
AC supply	N	1	XA
	L	2	
	⊕	3	
Relay contact <i>Default setting</i>	NO	1	XF
	C	2	
	NC	3	
Relay contact <i>Alarms 1 to 5</i>	NO	1	XR1 to XR5
	C	2	
	NC	3	
Remote acknowledgement		1	XACQ
		2	
External siren (Option)	0Vdc	1	XSIR
	+24Vdc	2	
External flashing lamp (Option)	0Vdc	1	XLU
	+24Vdc	2	
RS485 output	A	1	XRS485
	B	2	

To connect the 8 relay modules (ROM), 8 analog input modules (AIM), 4 analog outputs, 4-20mA (AOM) and 16 logic inputs (LIM).), please refer to chapter 6.

The detector cable screens should be connected to the common terminal strip for the digital and analog cable screening (G in Figure 58).

For the digital communication RS485, connect terminals 1 (A) and 2 (B) to the **XRS485** terminal. Use a 1 twisted pair screened cable, section 0.22 m<sup>2</sup> minimum, type MPI-22A, with nominal impedance of 100 Ohms (see chapter 11).

## 14.4 Control panel fixing

Securely mount the enclosure in accordance with the dimensions depending of the enclosure type.

### 14.4.1 Model MX43-EB polyester

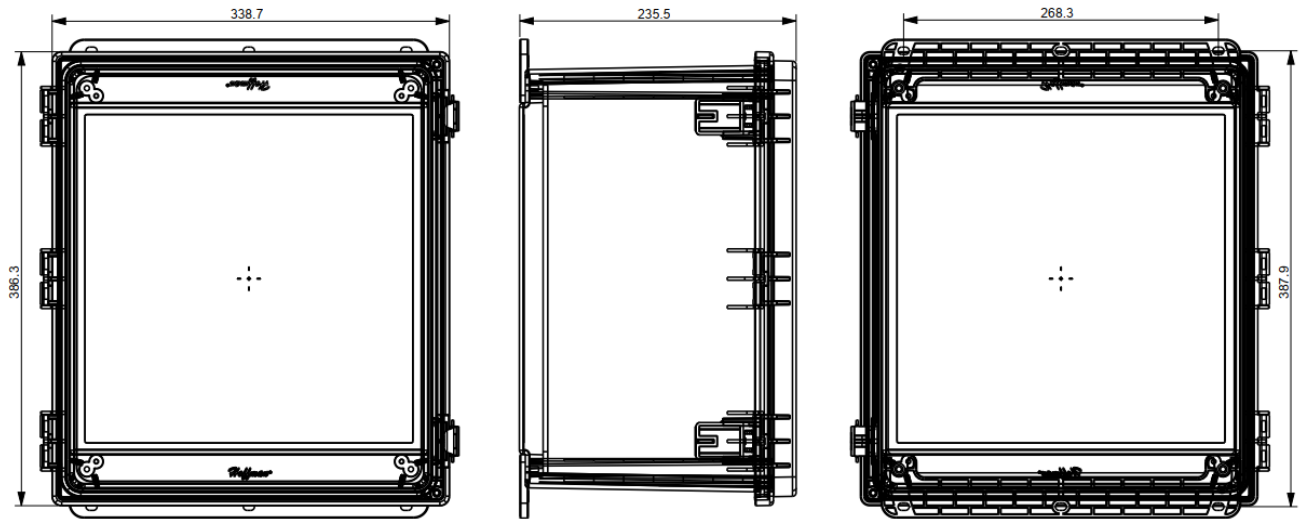

### 14.4.2 Model MX43-EB Painted and Stainless steel

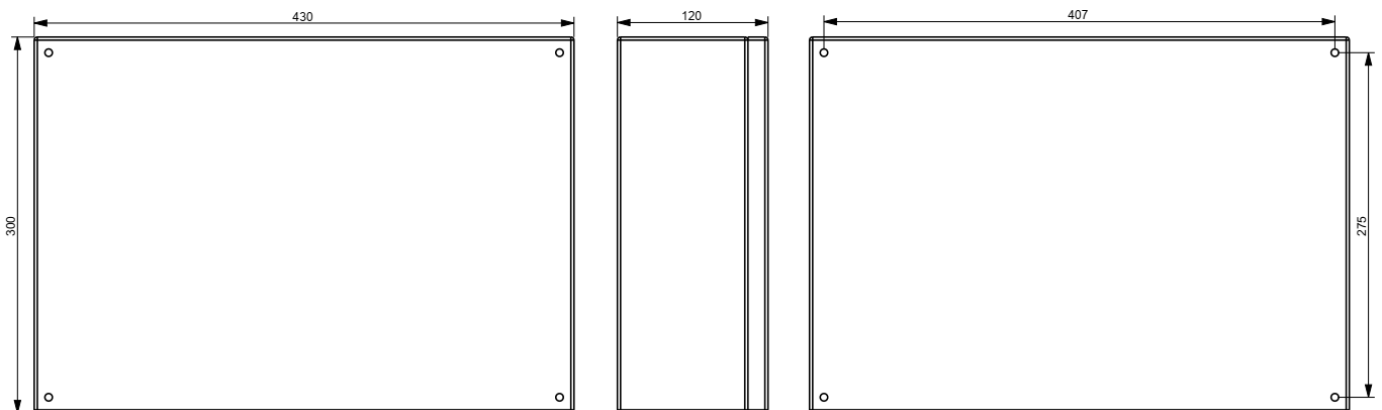

### 14.4.3 Model MX43-S polyester

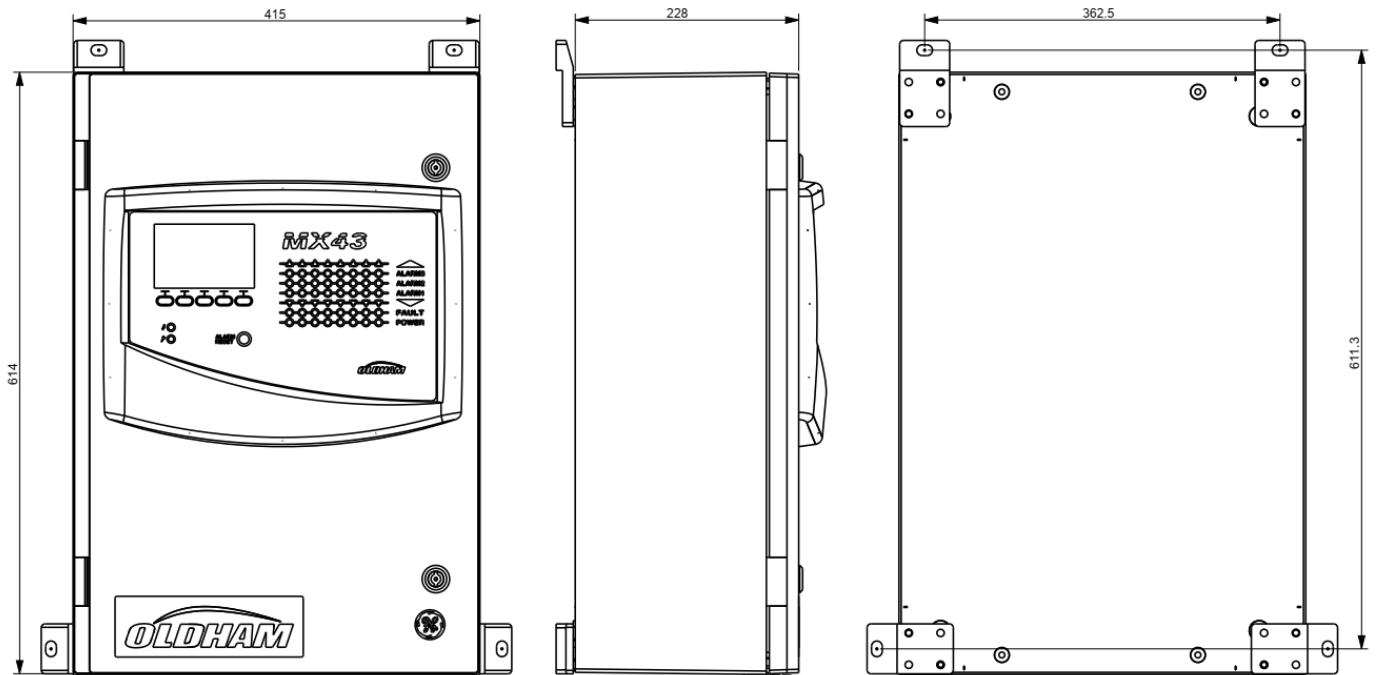

### 14.4.4 Model MX43-S Painted and Stainless steel

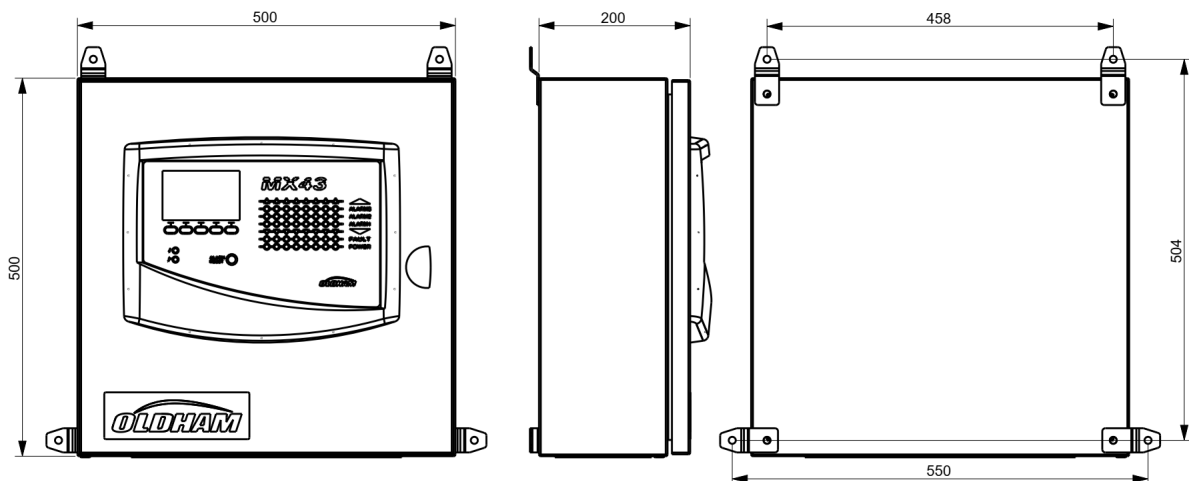

# MX 43

ANALOG AND DIGITAL CONTROLLER  
USER GUIDE

## 14.4.5 Model MX43-L polyester

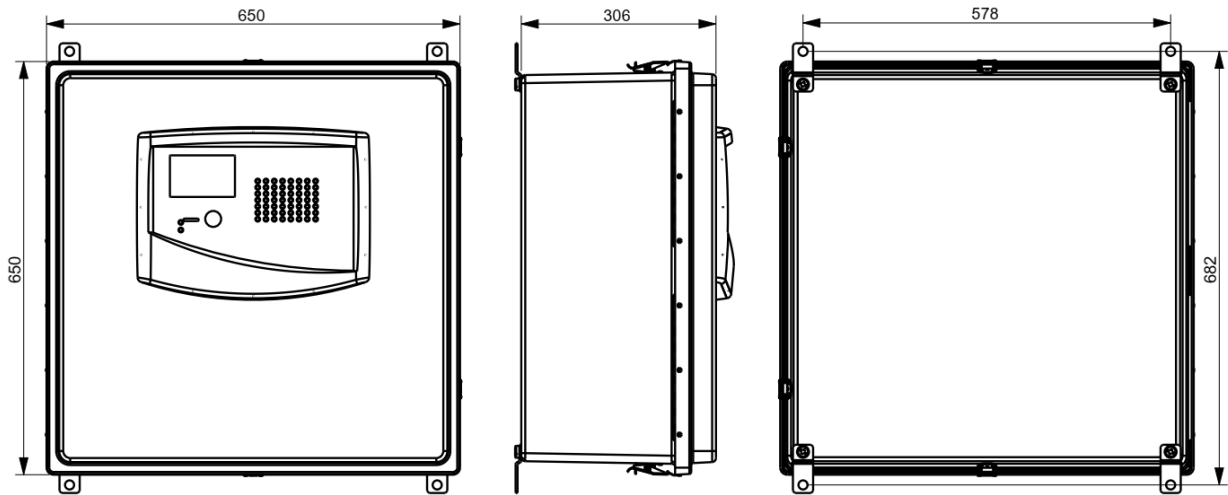

## 14.4.6 Model MX43-L Painted and Stainless steel

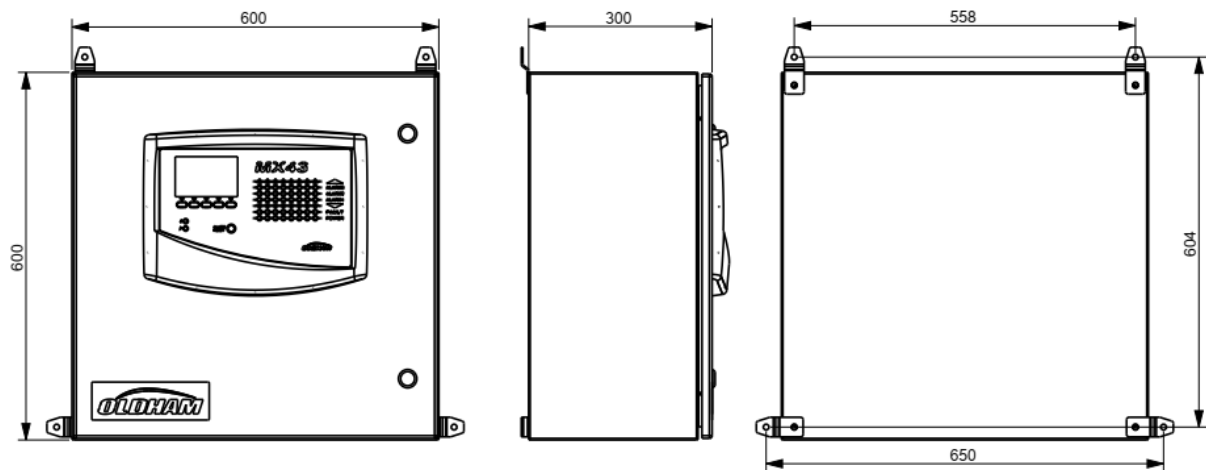

## 14.5 Internal implantation

### 14.5.1 Model MX43-EB in polyester (P/N MX43-EB-x-FI-1-x-x) with AC (10A) supply

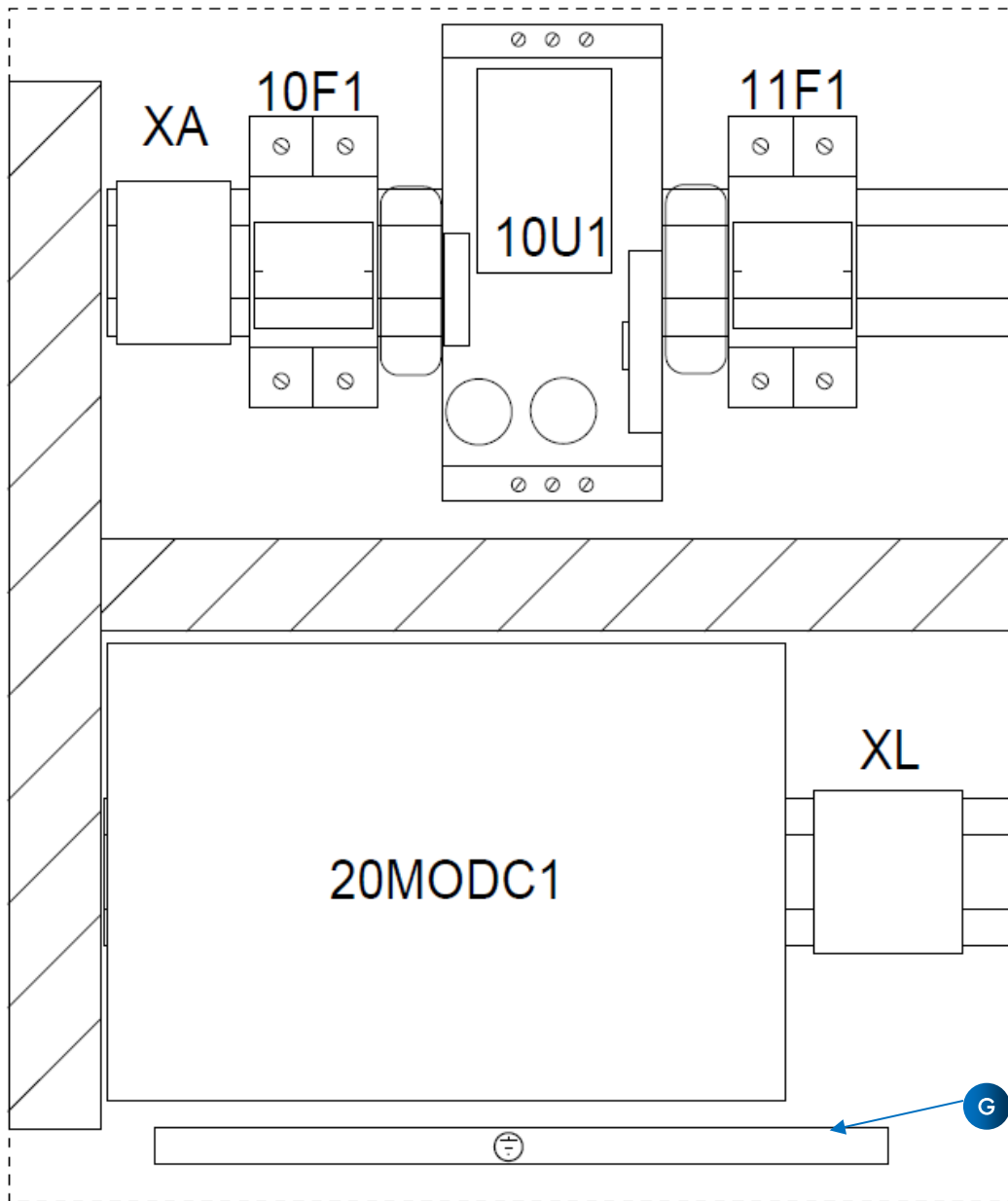

Figure 53 : Implantation of MX43-EB in polyester with AC supply

# MX 43

ANALOG AND DIGITAL CONTROLLER  
USER GUIDE

TAG	DESIGNATION	REFERENCE	MANUFACTURER
10F1	CYLINDRICAL FUSE Gg 10X38mm, 10A	013310	LEGRAND
10F1	FUSE HOLDER	DF102	GENERAL ELECTRIC
10U1	POWER SUPPLY UNIT PHOENIX, OUTPUT: 24 V DC/10 A	2866763	PHOENIX CONTACT
11F1	CYLINDRICAL FUSE Gg 10X38mm, 10A	013310	LEGRAND
11F1	FUSE HOLDER	DF102	SCHNEIDER ELECTRIC
XA	M4/6 SCREW CLAMP TERMINAL BLOCKS	1SNA115116R0700	ABB ENTRELEC
XA	END SECTIONS	1SNA118368R1600	ABB ENTRELEC
XA	M4/6.P SCREW CLAMP TERMINAL BLOCKS - GROUND - GREEN YELLOW	1SNA165113R1600	ABB ENTRELEC
XA	END STOP	1SNA206351R1600	ABB ENTRELEC
XL	M4/6 SCREW CLAMP TERMINAL BLOCKS	1SNA115116R0700	ABB ENTRELEC
XL	END SECTIONS	1SNA118368R1600	ABB ENTRELEC
XL	M4/6.P SCREW CLAMP TERMINAL BLOCKS - GROUND - GREEN YELLOW	1SNA165113R1600	ABB ENTRELEC
XL	END STOP	1SNA206351R1600	ABB ENTRELEC



14.5.2 Model MX43-EB in Painted and Stainless steel (P/N MX43-EB-x-ST-1-x-x) with AC (6A) supply

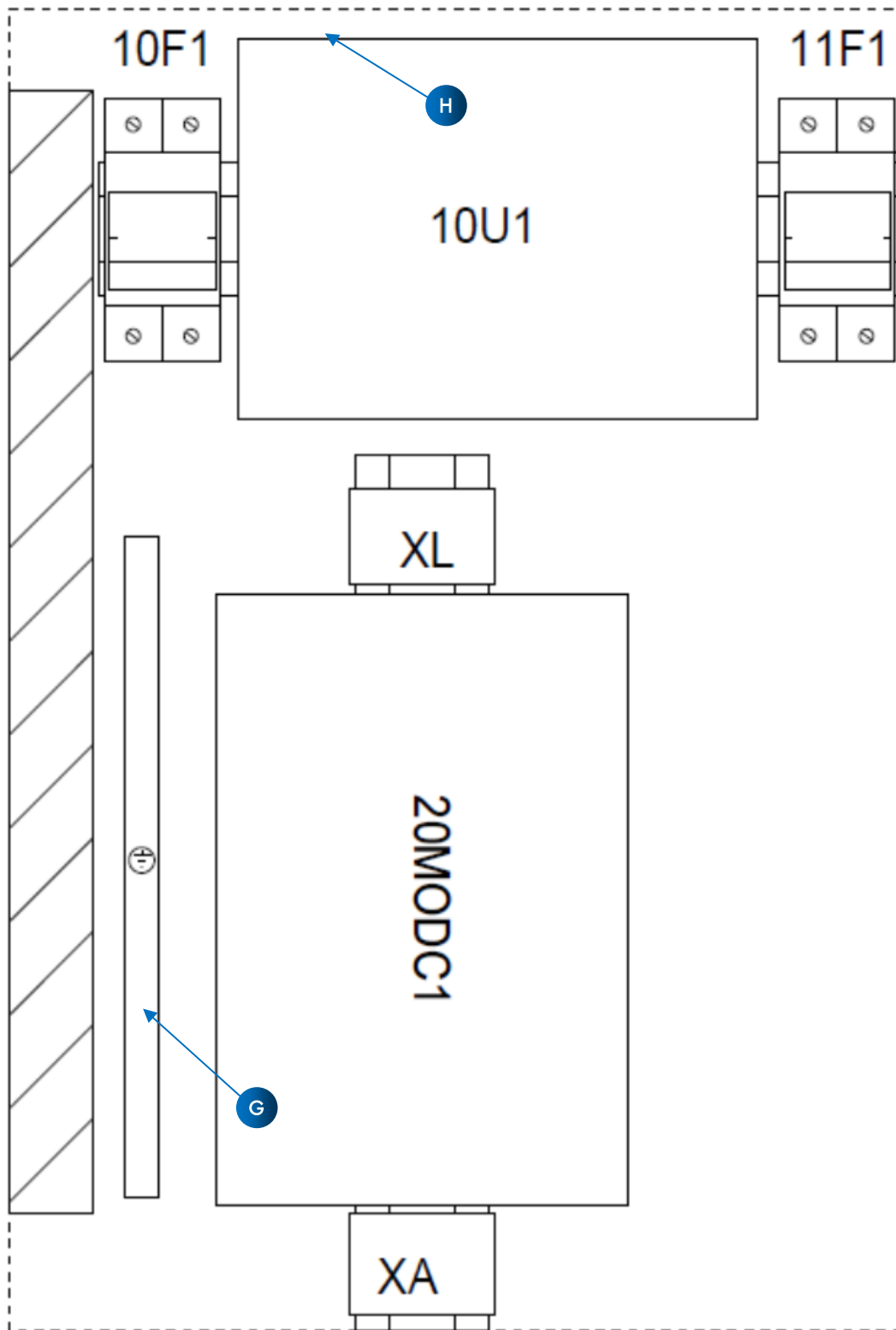

Figure 54 :Implantation of the MX43-EB in stainless steel with AC supply

# MX 43

ANALOG AND DIGITAL CONTROLLER  
USER GUIDE

TAG	DESIGNATION	REFERENCE	MANUFACTURER
10F1	CYLINDRICAL FUSE Gg 10X38mm, 6A	013306	LEGRAND
10F1	FUSE HOLDER	DF102	SCHNEIDER ELECTRIC
10U1	POWER SUPPLY 115/230 VAC/24VDC 6 50/60HZ	TIS 150-124	TRACO POWER
11F1	CYLINDRICAL FUSE Gg 10X38mm, 6A	013306	LEGRAND
11F1	FUSE HOLDER	DF102	SCHNEIDER ELECTRIC
XA	M4/6 SCREW CLAMP TERMINAL BLOCKS	1SNA115116R0700	ABB ENTRELEC
XA	END SECTIONS	1SNA118368R1600	ABB ENTRELEC
XA	M4/6.P SCREW CLAMP TERMINAL BLOCKS - GROUND - GREEN YELLOW	1SNA165113R1600	ABB ENTRELEC
XA	END STOP	1SNA206351R1600	ABB ENTRELEC
XL	M4/6 SCREW CLAMP TERMINAL BLOCKS	1SNA115116R0700	ABB ENTRELEC
XL	END SECTIONS	1SNA118368R1600	ABB ENTRELEC
XL	M4/6.P SCREW CLAMP TERMINAL BLOCKS - GROUND - GREEN YELLOW	1SNA165113R1600	ABB ENTRELEC
XL	END STOP	1SNA206351R1600	ABB ENTRELEC

**14.5.3 Model MX43-EB without supply (P/N MX43-EB-x-xx-0-x-x)**

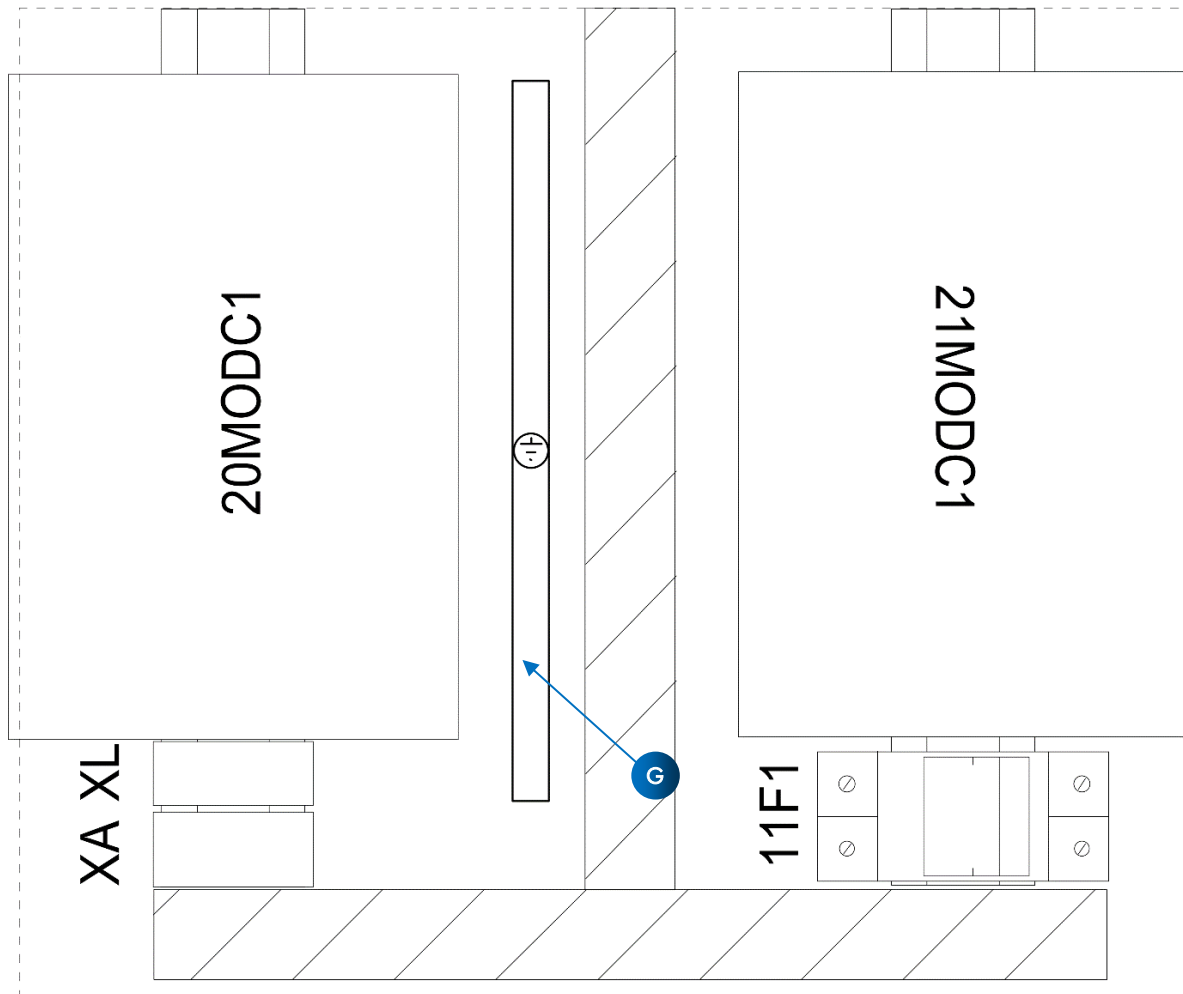

Figure 55 : Implantation of the MX43-EB without AC supply

TAG	DESIGNATION	REFERENCE	FABRICANT
11F1	CYLINDRICAL FUSE Gg 10X38mm, 6A	013306	LEGRAND
11F1	FUSE HOLDER	DF102	SCHNEIDER ELECTRIC
2XMODC1	ADDITIONAL MODULES - ANALOGUE INPUT MODULE	6314061	OLDHAM
2XMODC1	ADDITIONAL MODULES - MODULE 8 RELAYS	6313963	OLDHAM
XA	M4/6 SCREW CLAMP TERMINAL BLOCKS	1SNA115116R0700	ABB ENTRELEC
XA	END SECTIONS	1SNA118368R1600	ABB ENTRELEC
XA	M4/6.P SCREW CLAMP TERMINAL BLOCKS - GROUND - GREEN YELLOW	1SNA165113R1600	ABB ENTRELEC
XL	M4/6 SCREW CLAMP TERMINAL BLOCKS	1SNA115116R0700	ABB ENTRELEC
XL	END SECTIONS	1SNA118368R1600	ABB ENTRELEC
XL	SEPARATION PLATE	1SNA118707R0300	ABB ENTRELEC

### 14.5.4 Model MX43-S in polyester (P/N MX43-S-x-FI-x-x-x-x-x)

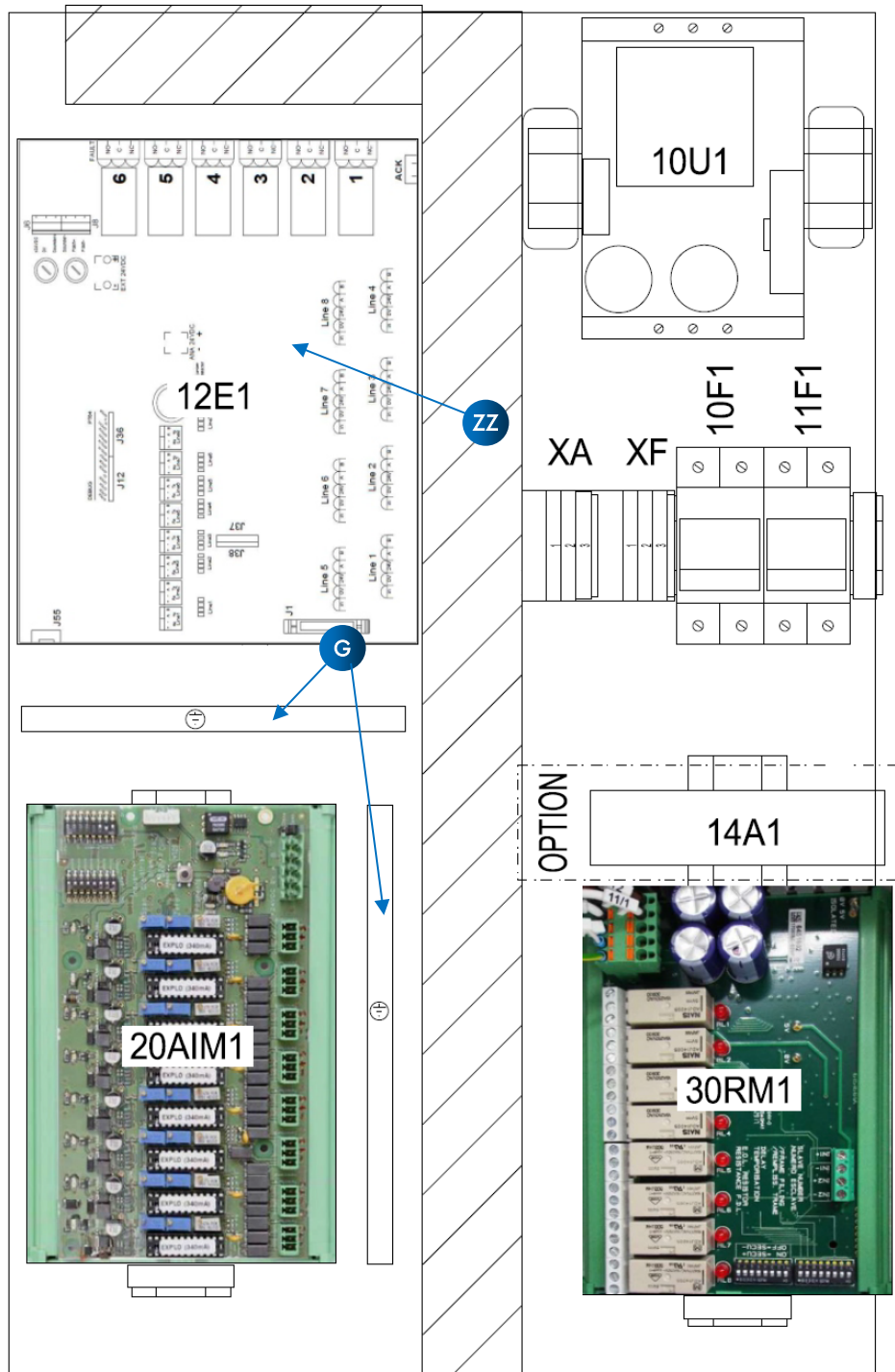

Figure 56 : Implantation of the MX43-S in polyester

TAG	DESIGNATION	REFERENCE	FABRICANT
10F1	CYLINDRICAL FUSE Gg 10X38mm, 10A	013310	LEGRAND
10F1	FUSE HOLDER	DF102	SCHNEIDER ELECTRIC
10U1	POWER SUPPLY UNIT PHOENIX, OUTPUT: 24 V DC/20 A DECOUPAGE PRIMAIRE, MONOPHASEE,	2866776	PHOENIX CPNTACT
11F1	CYLINDRICAL FUSE Gg 10X38mm, 16A	013316	LEGRAND
11F1	FUSE HOLDER	DF102	SCHNEIDER ELECTRIC
12E1	CPU MX43	6451635	OLDHAM
14A1	INDUSTRIAL MODBUS ETHERNET TO SERIAL GATEWAY 10...48VDC, 4Watts	MESR901	B+B ELECTRONICS
20AIM1	ANALOGUE INPUT MODULE	6314061	OLDHAM
30RM1	MODULE 8 RELAYS	6313963	OLDHAM
XA	END STOP	1SNA206351R1600	ABB ENTRELEC
XA	M4/6 SCREW CLAMP TERMINAL BLOCKS	1SNA115116R0700	ABB ENTRELEC
XA	M4/6.P SCREW CLAMP TERMINAL BLOCKS - GROUND - GREEN YELLOW	1SNA165113R1600	ABB ENTRELEC
XA	END SECTIONS	1SNA118368R1600	ABB ENTRELEC
XF	M4/6 SCREW CLAMP TERMINAL BLOCKS	1SNA115700R0500	ABB ENTRELEC
XF	END SECTIONS	1SNA115700R0500	ABB ENTRELEC

### 14.5.5 Model MX43-S in Painted and Stainless steel (P/N MX43-S-x-ST-x-x-x-x-x)

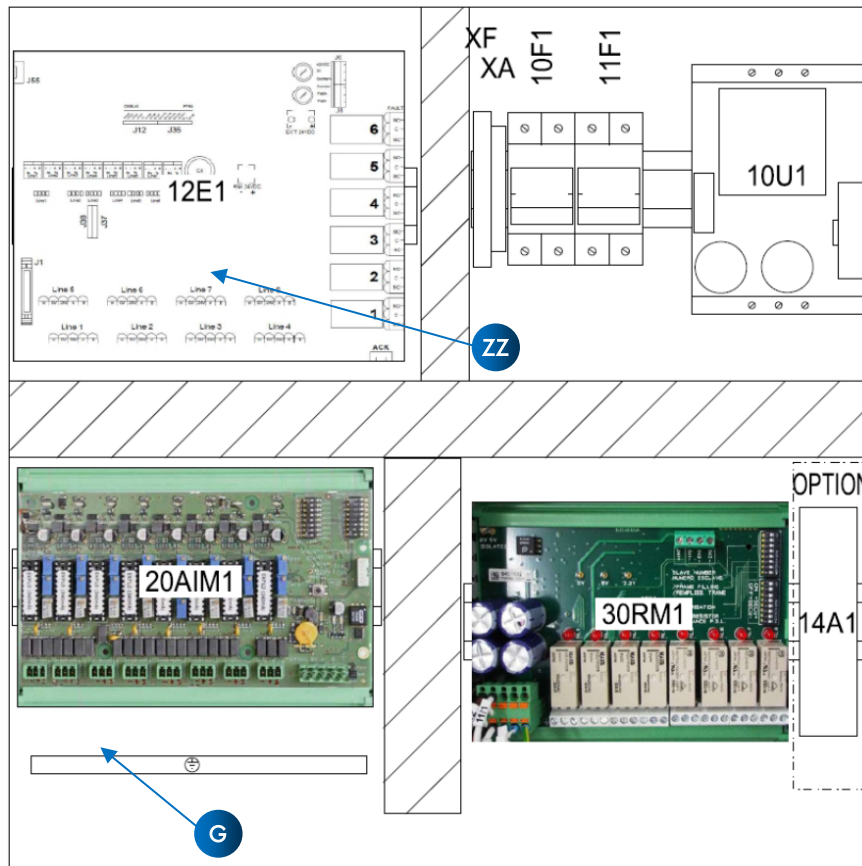

Figure 57: Implantation of the MX43-S in stainless steel

TAG	DESIGNATION	REFERENCE	FABRICANT
10F1	CYLINDRICAL FUSE Gg 10X38mm, 10A	013310	LEGRAND
10F1	FUSE HOLDER	DF102	SCHNEIDER ELECTRIC
10U1	POWER SUPPLY UNIT PHOENIX, OUTPUT: 24 V DC/20 A	2866776	PHOENIX CONTACT
11F1	CYLINDRICAL FUSE Gg 10X38mm, 16A	013316	LEGRAND
11F1	FUSE HOLDER	DF102	SCHNEIDER ELECTRIC
12E1	CPU MX43	6451635	OLDHAM
14A1	INDUSTRIAL MODBUS ETHERNET TO SERIAL GATEWAY 10...48VDC, 4Watts	MESR901	B+B ELECTRONICS
20AIM1	ANALOGUE INPUT MODULE	6314061	OLDHAM
30RM1	MODULE 8 RELAYS	6313963	OLDHAM
XA	SEPARATION PLAT	1SNA118495R1700	ABB ENTRELEC
XA	M4/6.D1.1 SCREW CLAMP TERMINAL BLOCKS, DOUBLE-TIER TERMINAL	1SNA115204R2000	ABB ENTRELEC
XA	END SECTIONS	1SNA118499R2300	ABB ENTRELEC
XF	D2.5/6.DA SCREW CLAMP TERMINAL BLOCKS, MULTI-TIER MODULAR TERMINAL	1SNA115541R1100	ABB ENTRELEC
XF	END SECTIONS	1SNA116771R2000	ABB ENTRELEC

### 14.5.6 Model MX43-L (all references)

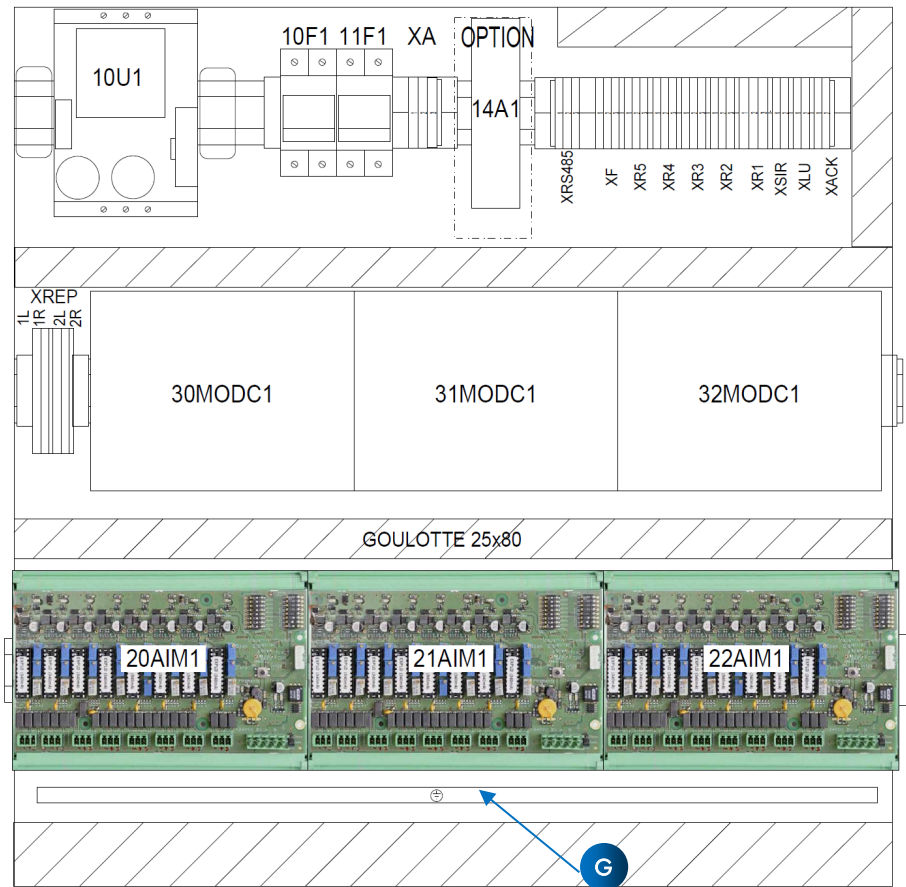

Figure 58 : Implantation of the MX43-L

TAG	DESIGNATION	REFERENCE	FABRICANT
10F1	CYLINDRICAL FUSE Gg 10X38mm, 10A	013310	LEGRAND
10F1	FUSE HOLDER STI 2P 500V 10.3x38mm	DF102	SCHNEIDER ELECTRIC
10U1	POWER SUPPLY UNIT PHOENIX, OUTPUT: 24 V DC/20 A	2866776	PHOENIX CONTACT
11F1	CYLINDRICAL FUSE Gg 10X38mm, 20A	013320	LEGRAND
11F1	FUSE HOLDER STI 2P 500V 10.3x38mm	DF102	SCHNEIDER ELECTRIC
12E1	CPU MX43	6451635	OLDHAM
14A1	INDUSTRIAL MODBUS ETHERNET TO SERIAL GATEWAY 10...48VDC, 4Watts	MESR901	B+B ELECTRONICS
20AIM1	ANALOG INPUT MODULE	6314061	OLDHAM
21AIM1	ANALOG INPUT MODULE	6314061	OLDHAM
22AIM1	ANALOG INPUT MODULE	6314061	OLDHAM
30MODC1	ADDITIONAL MODULE		OLDHAM
31MODC1	ADDITIONAL MODULE		OLDHAM
32MODC1	ADDITIONAL MODULE		OLDHAM
XA	M4/6 SCREW CLAMP TERMINAL BLOCKS	1SNA115116R0700	ABB ENTRELEC
XA	FEM6 END SECTIONS	1SNA118368R1600	ABB ENTRELEC

TAG	DESIGNATION	REFERENCE	FABRICANT
XA	M4/6.P SCREW CLAMP TERMINAL BLOCKS - GROUND - GREEN YELLOW	1SNA165113R1600	ABB ENTRELEC
XA	END STOP	1SNA206351R1600	ABB ENTRELEC
XACK	MA2.5/5 SCREW CLAMP TERMINAL BLOCKS	1SNA115486R0300	ABB ENTRELEC
XACK	END SECTIONS	1SNA118368R1600	ABB ENTRELEC
XACK	END STOP	1SNA206351R1600	ABB ENTRELEC
XF	MA2.5/5 SCREW CLAMP TERMINAL BLOCKS	1SNA115486R0300	ABB ENTRELEC
XF	END SECTIONS	1SNA114825R0500	ABB ENTRELEC
XLU	MA2.5/5 SCREW CLAMP TERMINAL BLOCKS	1SNA115486R0300	ABB ENTRELEC
XLU	END SECTIONS	1SNA114825R0500	ABB ENTRELEC
XR1	MA2.5/5 SCREW CLAMP TERMINAL BLOCKS	1SNA115486R0300	ABB ENTRELEC
XR1	END SECTIONS	1SNA114825R0500	ABB ENTRELEC
XR2	MA2.5/5 SCREW CLAMP TERMINAL BLOCKS	1SNA115486R0300	ABB ENTRELEC
XR2	END SECTIONS	1SNA114825R0500	ABB ENTRELEC
XR3	MA2.5/5 SCREW CLAMP TERMINAL BLOCKS	1SNA115486R0300	ABB ENTRELEC
XR3	END SECTIONS	1SNA114825R0500	ABB ENTRELEC
XR4	MA2.5/5 SCREW CLAMP TERMINAL BLOCKS	1SNA115486R0300	ABB ENTRELEC
XR4	END SECTIONS	1SNA114825R0500	ABB ENTRELEC
XR5	MA2.5/5 SCREW CLAMP TERMINAL BLOCKS	1SNA115486R0300	ABB ENTRELEC
XR5	END SECTIONS	1SNA114825R0500	ABB ENTRELEC
XRS485	MA2.5/5 SCREW CLAMP TERMINAL BLOCKS	1SNA115486R0300	ABB ENTRELEC
XRS485	END SECTIONS	1SNA118368R1600	ABB ENTRELEC
XRS485	END STOP	1SNA206351R1600	ABB ENTRELEC
XSIR	MA2.5/5 SCREW CLAMP TERMINAL BLOCKS	1SNA115486R0300	ABB ENTRELEC
XSIR	END SECTIONS	1SNA114825R0500	ABB ENTRELEC
XREP	FEED-THROUGH TERMINAL, PDU 2.5/4/4AN, PUSH IN, 4mm <sup>2</sup> , 800V, 32A	1896130000	WEIDMULLER
XREP	CROSS-CONNECTOR ZQV 2.5/4, 24A	1608880000	WEIDMULLER
XREP	END SECTIONS, PAP 2.5/4/4AN	1896320000	WEIDMULLER



## 14.6 Technical specifications

### 14.6.1 Model MX43-EB

Function	
Function	Remote modules E/S (see chapter 11 for the characteristics of each module)
Capacity	2 modules maxi (or 1 module and 1 AC/DC supply)

Electrical characteristics	
AC/DC supply Model MX43-EB-xx-ST	<ul style="list-style-type: none"> <li>• 95 Vac to 130 Vac - 190 Vac to 260 Vac, 50/60 Hz</li> <li>• Output current 6A at 24Vdc</li> </ul>
AC/DC supply Model MX43-EB-xx-FI	<ul style="list-style-type: none"> <li>• 100 Vac to 240 Vac, 50/60 Hz</li> <li>• Output current 10A at 24Vdc</li> </ul>
DC supply Model MX43-EB-xx-xx-0	<ul style="list-style-type: none"> <li>• ■ 21 to 28 Vdc, 10 A max</li> <li>• ■ maximum consumption: 240 W</li> </ul>

Environmental characteristics	
Working temperature	-20 to +50 °C
Storage temperature	-20 to +50 °C
Humidity	5 to 95 % non condensing
Protection rating	NEMA 4, IP65

Standards	
CEM	According to EN50270, type 2 industrial
ATEX	According to 60079-29-1 and EN50271
Low Voltage Directive	According to EN61010
CSA	According to C22.2 No.152 (pending)

## 14.6.2 Model MX43-S

Function	
Capacity (Depending on model)	<p>Up to 32 analog and/or digital detectors</p> <p>1 default none configurable relay</p> <p>5 to 29 configurable alarm relays</p> <p>MX43-S without module:</p> <p>7 analog inputs</p> <p>1 default none configurable relay</p> <p>5 configurable alarm relays</p> <p>2 reserve modules from:</p> <p>AIM (2 max)</p> <p>ROM (2 max)</p> <p>AOM (2 max)</p> <p>LIM (2 max)</p>



(See chapter 11 for the characteristics of each module)

Display and lamps	
Display	Back lit LCD graphic display
Warning lamps	<ul style="list-style-type: none"> <li>• 7 LED for each of the 8 lines</li> <li>• 1 warning lamp indicating power on to main panel</li> <li>• 1 warning lamp for general fault</li> </ul>
Keys	
Selection	5 multifunction soft keys
Alarm acknowledgement	Dedicated soft key
Alarms	
Thresholds	Settings via <i>COM 43 application</i>
Lamps	6 LED warning lamps per line (Upper and lower range exceeded, Alarm 3, Alarm 2, Alarm 1, Fault)
Relay outputs	<ul style="list-style-type: none"> <li>• 5 alarm relays fully programmable, tripped on detection or lack of power via <i>COM 43 application</i>. Output on terminals found on the mother-board (rep H, Figure 10 p18)</li> <li>• 1 fault relay supplied during normal operation (non modifiable). Output on terminal XF.</li> <li>• Contacts RCT, 5A at 250 Vac or 30 Vdc</li> </ul>

**Measurement lines**

Digital lines	<ul style="list-style-type: none"> <li>• 8, one of which reserved for internal modules</li> <li>• Network communication wires, 1 or 2 screened, twisted pairs (1 for 24Vdc supply and 1 for communication), nominal impedance 100 Ohm</li> </ul>
Analog lines	<ul style="list-style-type: none"> <li>• 7 maximum</li> <li>• Input range 4 to 20 mA</li> <li>• Load resistance 120 Ohm</li> <li>• Screened instrumentation wire, 2 or 3 wires</li> </ul>
Maximum current per line	<ul style="list-style-type: none"> <li>• 1,2 A (1,5 A peak)</li> </ul>
Total maximum current for lines 2 to 8	3,2 A continuously or 4 A peak
Total available power depending on temperature	Ambient T° ≤ 60 °C = 480 W Ambient T° 60 to 70 °C = 360 W
Connections	Screw terminals Maximum conductor section = 2.5 mm <sup>2</sup>

**Electrical characteristics**

Alternative supply	<ul style="list-style-type: none"> <li>• 100 to 240 Vac, 50/60 Hz, 5.1 A at 120 Vac and 2.3 A at 230 Vac</li> </ul>
--------------------	---

**Environmental characteristics**

Working temperature	-20 to +50 °C
Storage temperature	-20 to +50 °C
Humidity	5 to 95 % non condensing
Protection rating	NEMA 4, IP65

**Standards**

CEM	According to EN50270, type 2 industrial
ATEX	According to 60079-29-1 and EN50271
Low Voltage Directive	According to EN61010
CSA	According to C22.2 No.152 (pending)

### 14.6.3 MX43-L panel

#### Function

Capacity	<p>As standard:</p> <ul style="list-style-type: none"> <li>24 analog inputs</li> <li>1 non configurable default relay</li> <li>5 configurable alarm relays</li> </ul> <p>3 reserve modules from:</p> <ul style="list-style-type: none"> <li>AIM (1 max)</li> <li>ROM (3 max)</li> <li>AOM (3 max)</li> <li>LIM (2 max)</li> </ul>
 (See chapter 11 for the characteristics of each module)	

#### Display and lamps

Display	Back lit LCD graphic display
Warning lamps	<ul style="list-style-type: none"> <li>■ 7 LED for each of the 8 lines</li> <li>■ 1 warning lamp indicating power on to main panel</li> <li>■ 1 warning lamp for general fault</li> </ul>

#### Keys

Selection	5 multifunction soft keys
Alarm acknowledgement	Dedicated soft key

#### Alarms

Thresholds	Settings via <i>COM 43 application</i>
Lamps	6 LED warning lamps per line (Exceeding high and low range, Alarm 3, Alarm 2, Alarm 1, Fault)
Internal relays	<ul style="list-style-type: none"> <li>• 5 fully programmable relays, tripped on presence or lack of power via <i>COM 43 application</i></li> <li>• 1 fault relay supplied during normal operation (non modifiable).</li> <li>• Contacts RCT, 5A at 250 Vac or 30 Vdc</li> <li>• Output on screw terminals. Maximum conductor section = 2.5 mm<sup>2</sup> (Terminals XR1 to XR5 and XF)</li> </ul>

#### Environmental characteristics

Working temperature	-20 to +50 °C
Storage temperature	-20 to +50 °C
Humidity	5 to 95 % non condensing

Protection rating	NEMA 4, IP65
<b>Standards</b>	
CEM	According to EN50270, type 2 industrial
ATEX	According to 60079-29-1 and EN50271
Low Voltage Directive	According to EN61010
CSA	According to C22.2 No.152 (pending)

# **MX 43**

ANALOG AND DIGITAL CONTROLLER  
USER GUIDE







**TELEDYNE**  
**OLDHAM SIMTRONICS**  
Everywhereyoulook™



**AMERICAS**

14880 Skinner Rd  
CYPRESS  
TX 77429,  
USA  
Tel.: +1-713-559-9200

**EMEA**

Rue Orfila  
Z.I. Est – CS 20417  
62027 ARRAS Cedex,  
FRANCE  
Tel.: +33 (0)3 21 60 80 80

**ASIA PACIFIC**

Room 2722,  
No. 51 Jinzang Road,  
Shanghai Free Trade Zone,  
CHINA  
Tel.: +86-134-8229-5057

[www.teledynegasandflamedetection.com](http://www.teledynegasandflamedetection.com)



© 2020 Teledyne Oldham Simtronics. All right reserved.

NPM43EN Revision K.1 /December 2020